

# Product Naming Rule v20251208

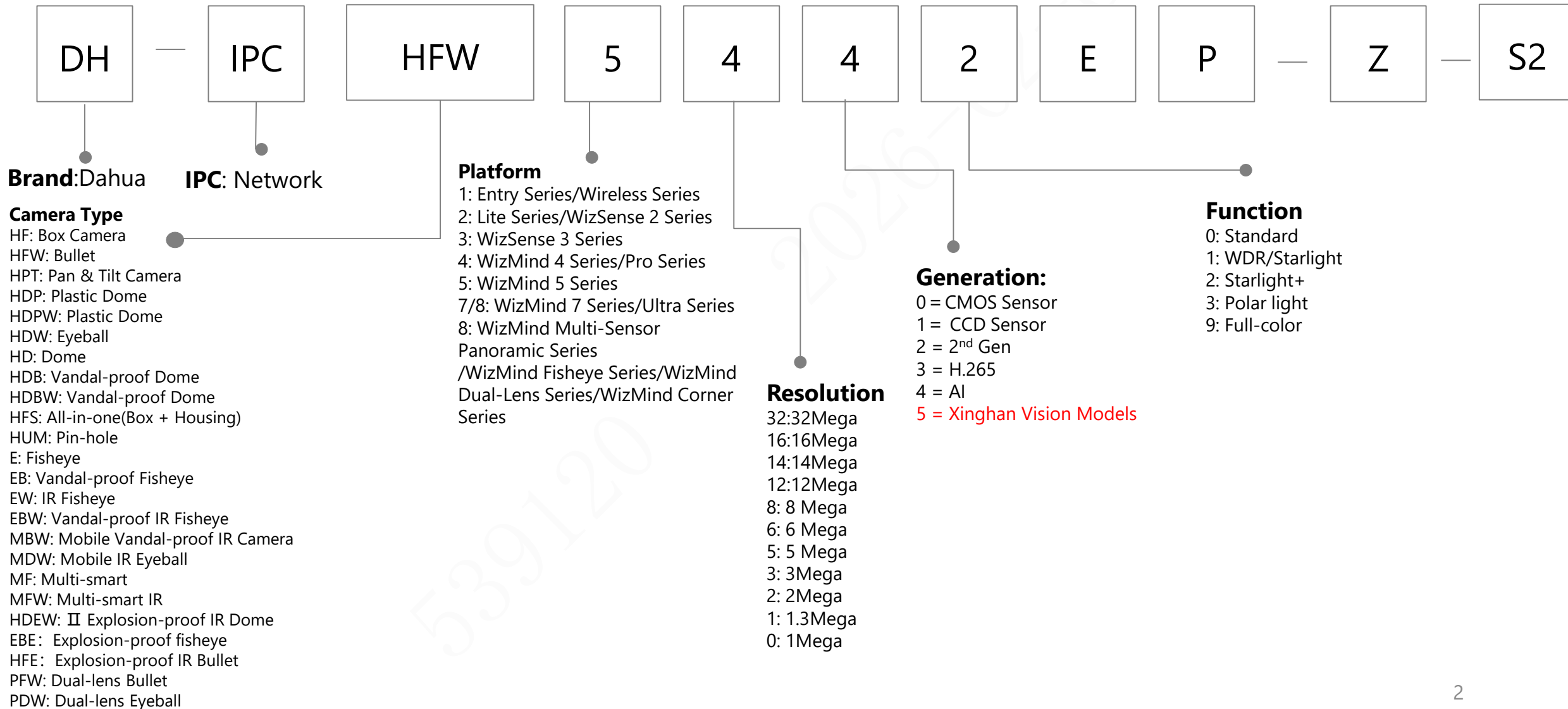

Page	Product	Page	Product
1	/	54-59	Access Control
2-9	Network Camera (Updated)	60-61	Alarm
10-12	HDCVI Camera (Updated)	62-74	ITS (Intelligent Traffic System)
13-15	PTZ Camera	75-77	ICS (Intelligent Charging Solution)
16-17	Interactive Whiteboards	78	Dahua Memory
18-25	Accessory	79-82	Thermal Camera (Updated)
26-28	Network Recorder (Updated)	83-97	Display & Control
29-32	HDCVI Recorder	98-101	Security Screening Products
33-35	Intelligent Computing	102-107	Mobile Products
36-42	Transmission	108-110	Fire Alarm (Updated)
43-45	MPT	111-116	HYXiPOWER
46	DSS		
47-53	Video Intercom (Updated)		

# Network Camera(1/2)



# Network Camera(2/2)



## Appearance

- C: Bullet/Mini Dome
- E: Bullet / Dome / Eyeball
- E1: Plastic+metal Dome
- TC: Metal Bullet
- EM: Metal Eyeball
- F: Dome / Box Camera / Bullet
- G: Indoor Dome
- H: VF Bullet (with junction box) / Dome(with junction box) / Eyeball
- M/M1: Bullet
- R: Metal Vandal-proof Dome / Metal Bullet/Metal Eyeball
- R1: Dome
- S: Eyeball / Bullet
- S1: S1 Eyeball
- T: Bullet / Eyeball
- T1: T1 Bullet/T1 Eyeball
- T2: T2 Bullet
- TM: Metal Eyeball
- X: Dual-Lens Camera
- DS1: Non-PoE S1 Bullet
- DV: Non-PoE Eyeball
- DG: Non-PoE G Bullet
- DF: Non-PoE F Bullet

- DK1: Non-PoE K1 Bullet
- DR1: Non-PoE R1 Dome
- QM: Quick Installation Metal Eyeball
- TL: TL Metal Bullet
- HA: Indoor PT A Appearance Camera
- PA: Outdoor PT A Appearance Camera
- Z: PTRZ Dome and Z type Bullet
- Z1: Z1 type Bullet with junction box
- J: Self-Cleaning Bullet

## Video format

- P: PAL
  - N: NTSC
- (Cancellation of P/N mark for external models of products released after 2021)

## Common function:

- |  |   |
|--|---|
| BV: Behaviors                          | 4G: 4G  |
| W: WIFI                                | WG: WiFi & GPS  |
| AW: Audio/Alarm/SD WIFI Camera         | FD: Face Detection  |
| E: E PoE                               | FR: Face Recognition  |
| M/M12: Mobile                          | ME: Mobile dome   |
| F: Fiber interface                     | U:USB   |
| H: Heater                              | D2: Dual sensor   |
| A: Built-in MIC(only for Entry Series) | IL: Smart Dual Light  |
| A2: Dual Audio                         | P: Wide Angle   |
| PT: pan &Tilt                          | SP: Solar Panel   |
| S: SD card                             | 180: 180°   |
| AS: Audio & Alarm & SD Card            | E2: 2 lens  |
| VF: Vari-focal                         | E3: 3 lens  |
| T: Built-in Mic & Speaker              | HDMI: HDMI Port   |
| Z: Motorized lens                      | PRO: WizColor   |
| Ix: IR numbers                         | <b>PROX: WizColor 2.0</b>                                   |
| NI: Full color, non IR                 | BAT: Battery  |
| LED: White light illumination          | MAX: Enhanced version, generally refers to battery capacity |
| Z4/5/12: 4/5/12X zoom                  | ATC: Anti-corrosion   |
| L1/L2/L3/L4/L5: Lens                   | PD: Parking space status detection                          |
| MF: High Frame                         | A: Splicing   |
| SFC: Separated Front Cover             | B: No-splicing  |
| 3D: 3 Dimensional                      | AC: AC220V power  |
| LI: Dual Light Fusion                  | <b>SC: Self-Cleaning</b>                                    |
| PV: Perimeter Vigilance                |   |
| 5G: 5G                                 |   |

- S2: Second generation
- Sn: Nth generation

# Network Camera(Multi-sight Series)

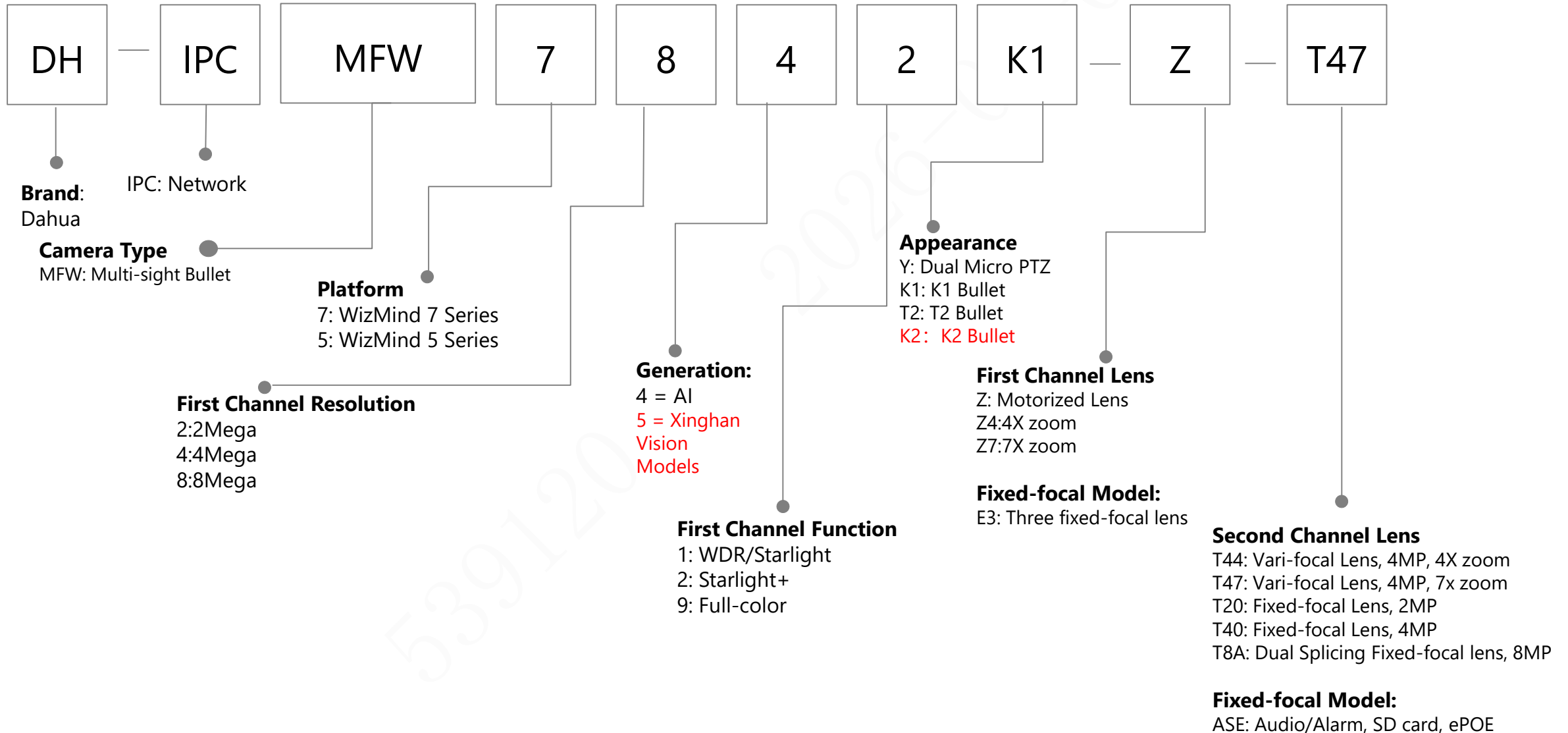

# Network Camera (Panoramic Series)

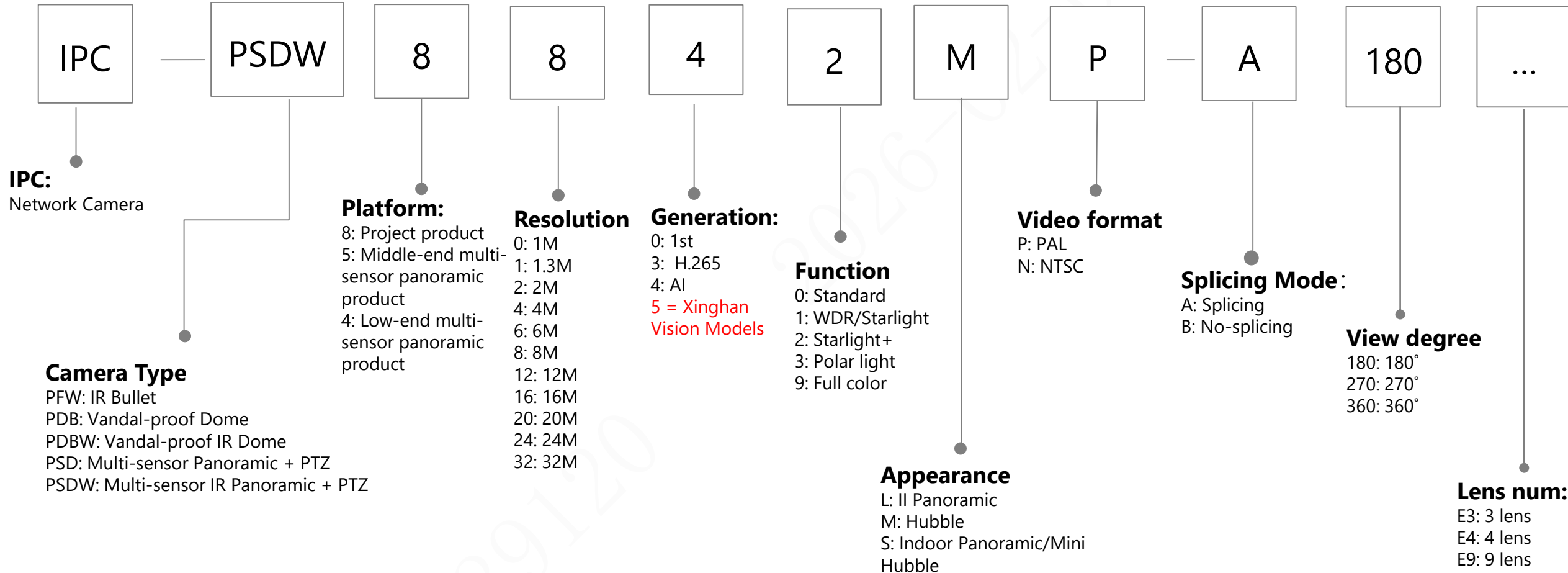

# Network Camera (ECO Series)

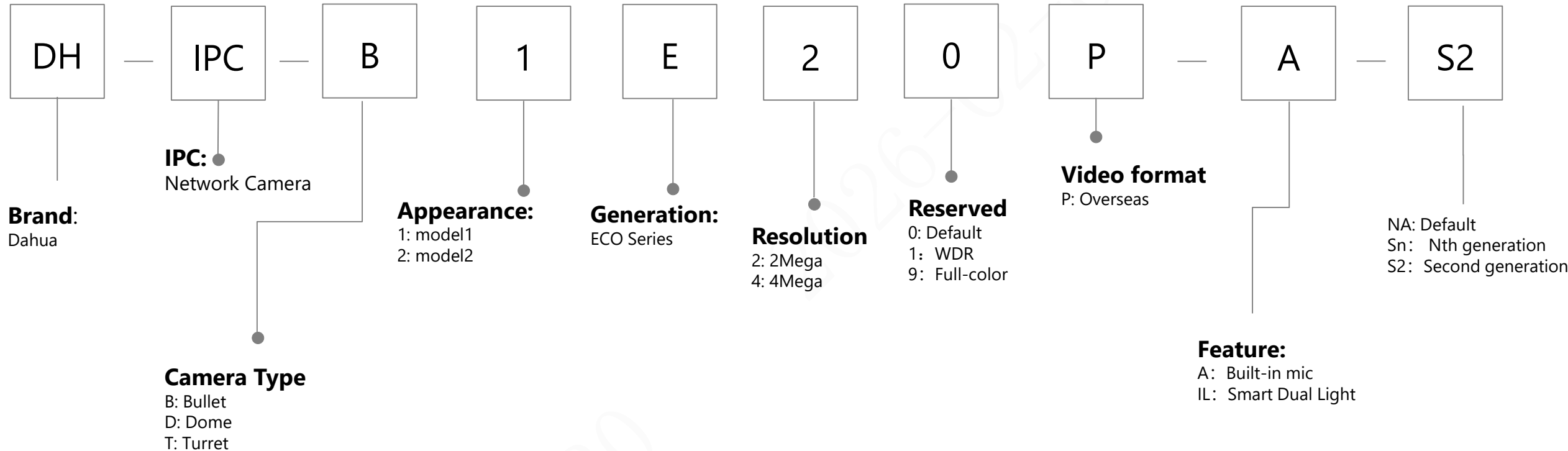

For example: 4MP ECO Smart Dual Light Fixed-focal Bullet Network Camera

Internal Model: DH-IPC-B1E49P-A-IL-0360B-S2

External Model: DH-IPC-B1E49-A-IL

# Network Camera(Wireless Series-IT Channel)

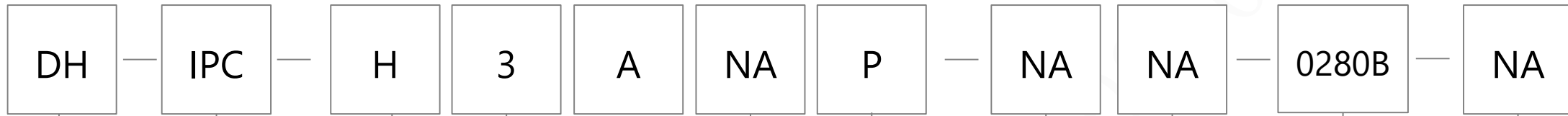

**Brand:**Dahua

IPC: Network

### Camera Type

- C: Cube Camera
- H: Indoor PT Camera
- P: Outdoor PT Camera
- T: Turret Camera
- F: Bullet Camera
- D: Dome Camera
- L: Floodlight Camera
- B: Battery Camera
- BF: Battery Bullet Camera
- BH: Battery Indoor PT Camera
- BP: Battery Outdoor PT Camera

### Resolution

- 5: 5 Mega
- 4: 4 Mega
- 3: 3 Mega
- 2: 2 Mega

### Appearance

- A: A Appearance
- B: B Appearance
- C: C Appearance
- .....

- NA: Default
- C: Cost down
- E: Enhancement
- S: Supreme

### Identification:

P: Overseas

### Lens Type:

- NA: Default
- Zx: x times Electric Zoom
- xZx: x Resolution \* x times Electric Zoom
- xF: x Resolution Fixed Focus

### Common Function:

- NA: Wi-Fi
- LED: warm light
- IL: Smart Dual Light
- 4G: Support 4G
- 5G: Support 5G
- P: PoE
- PV: Perimeter Vigilance  
(Battery Camera not add "-PV")

### Lens:

- 0210B: 2.1mm
- 0280B: 2.8mm
- 0360B: 3.6mm
- 0600B: 6mm
- 0800B: 8mm

### Additional Attribute

- NA: Default
- 1. Hardware generation:  
S2: Second generation  
Sn: Nth generation
- 2. Battery type:  
MAX= Wide Temperature Battery  
XL=Large-Capacity Battery Version
- 3. Color:  
Ash  
Pearl
- 4. WizColor: PRO
- 5. Region: EUR

# Network PT Camera(1/2)

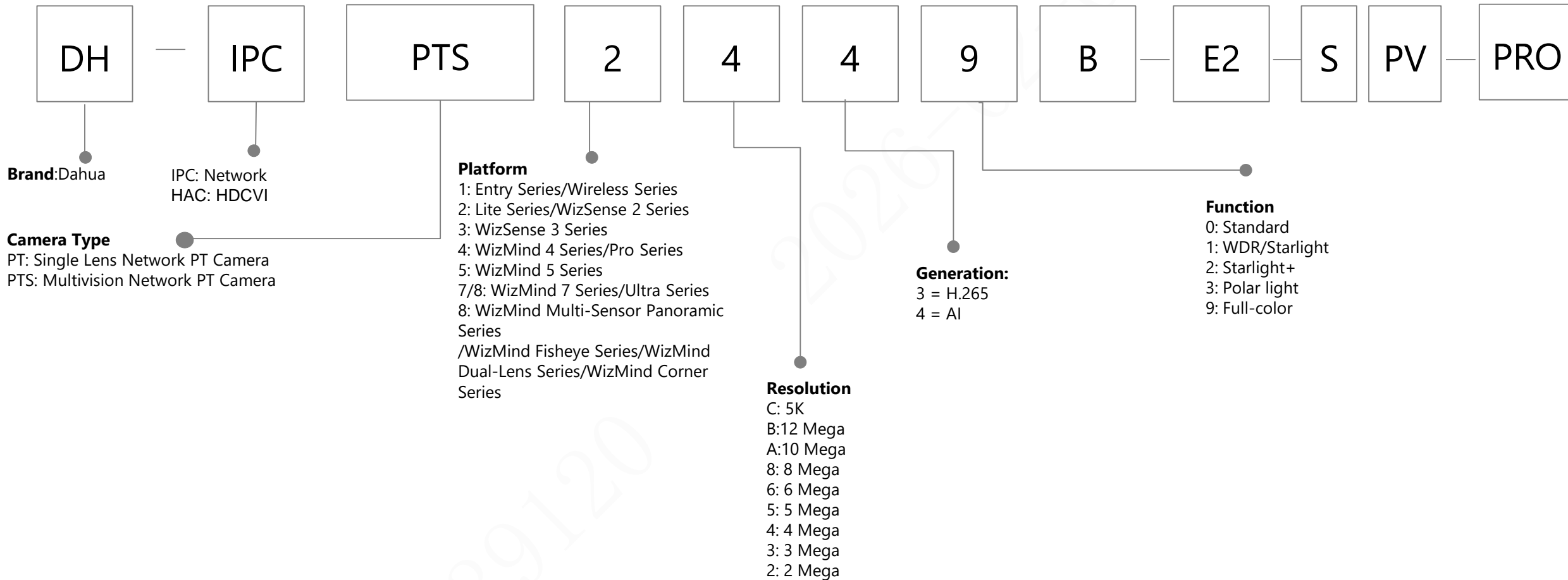

# Network PT Camera(2/2)



## Appearance

D: Non-PoE Model  
 H: Indoor Eyeball  
 Ax: Outdoor 1 Series PT camera  
 Bx: Outdoor 2 Series PT camera  
 Cx: Outdoor 3 Series PT camera

## Multi-lens Model:

x= panoramic channel resolution  
 , If it is the same as the detail channel, it did not show.  
 y= total number of panoramic and detail lenses

## Common function:

S: SD Card(PT-1 Series); SD Card+Mic(Except PT-1 Series)  
 SA: SD Card+Mic (Only for PT-1 Series)  
 AS: Audio & Alarm & SD Card  
 SW: SD Card+WiFi  
 SAW: SD Card+Mic+WiFi  
 ST: SD Card+Two way talk(Indoor Type)  
 STW: SD Card+Two way talk+WiFi  
 STWB20: SD Card+Two way talk+WiFi+20000mAh Battery  
 Z: Hybrid Zoom  
 4G: 4G  
 5G: 5G  
 PV: Perimeter Vigilance (Outdoor Type)  
 IL: Smart Dual Light  
 LED: Warm Light  
 .....

PRO: WizColor  
 BK: Black color model  
 Sn: Nth generation  
 Pearl: Pearl White  
 Ash: Metal grey  
 Jordan: Jordan model  
 USA: US model  
 CAN: Canada model  
 .....

# HDCVI Camera (1/2)

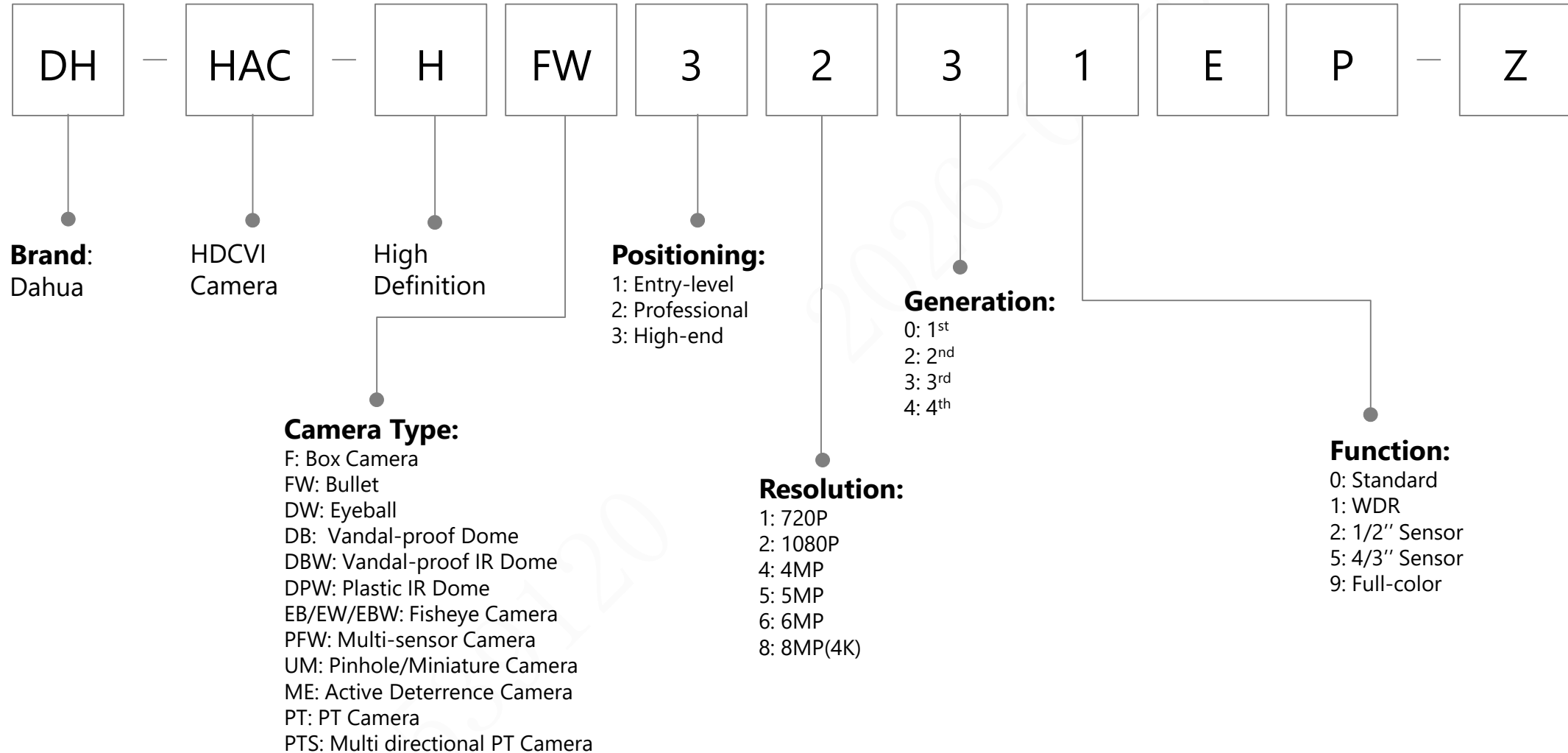

# HDCVI Camera (2/2)

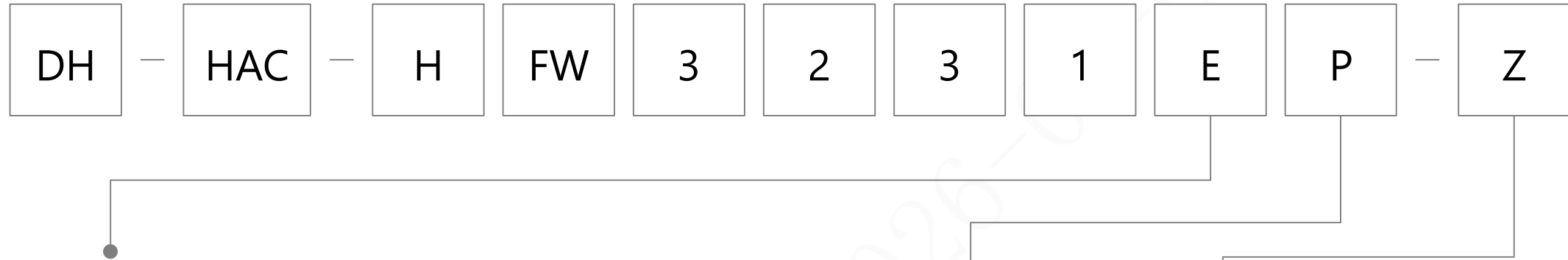

**Case:**

- A: IR Cube/ PT Camera
- B: Active Deterrence Bullet/ Pinhole Camera/PT Camera
- C: Active Deterrence Bullet / Plastic Bullet/PT Camera
- CL: Plastic Bullet
- RL: Plastic Bullet
- CLQ: Quick-to-install Plastic Eyeball
- CM: Metal Bullet
- RM: Metal Bullet
- D: Active Deterrence Bullet/ Metal Bullet
- E: Metal Bullet/Metal Dome
- EA: Metal Dome
- EQ: Active Deterrence Quick-to-install Eyeball
- EM: Metal Eyeball
- F: Metal Wedge Dome
- G: Micro-size Bullet/ Box
- H: TiOC Metal Eyeball

- M: Metal Eyeball
- R: Plastic Bullet/ Plastic Eyeball
- RA: Metal Dome
- R-Z: Metal Bullet/ Metal Dome
- S: Metal Bullet
- T: Metal Bullet/ Metal Eyeball
- T-Z: Metal Bullet/ Metal Eyeball
- T-I8: Large size Metal Bullet
- TE: Metal+Plastic Eyeball
- TH-I4: IR 40m Bullet (Metal Bracket)
- TH-I8: IR 80m Bullet (Metal Bracket)
- TL: Bullet/Eyeball
- TLM: Metal Bracket Bullet
- TM: Metal Bullet
- X: Wizcolor Bullet/Eyeball
- TQ: Quick-to-install Eyeball (82mm)
- TLQ: Quick-to-install Eyeball (69mm)
- TLMQ: Quick-to-install Metal Eyeball(69mm)
- TMQ: Quick-to-install Metal Eyeball (82mm)
- TRQ: Quick-to-install Eyeball (Without IP67) (69mm)

**Video Format:**

- P: PAL
- N: NTSC

**Feature:**

- VF: Manual vari-focal
- Z: Motorized vari-focal
- H: With built-in heater
- T: Two-way Talk
- A: Built-in mic
- DP: Dual-power (AC24V/DC12V)
- POC: Power over coax
- LED: White light
- DIP: Dip switch
- VP: Vandal proof
- TH: Temperature & Humidity
- IL: Smart Dual Light
- E2: Dual lens
- E2Z: Dual lens hybrid vari-focal
- W: Wireless
- IRE6: IR 60m
- PIR: PIR Camera
- L: White Light
- S: Siren
- LS: White Light & Siren
- PV: TiOC Camera

# HDCVI Cooper Series (Camera & Recorder)

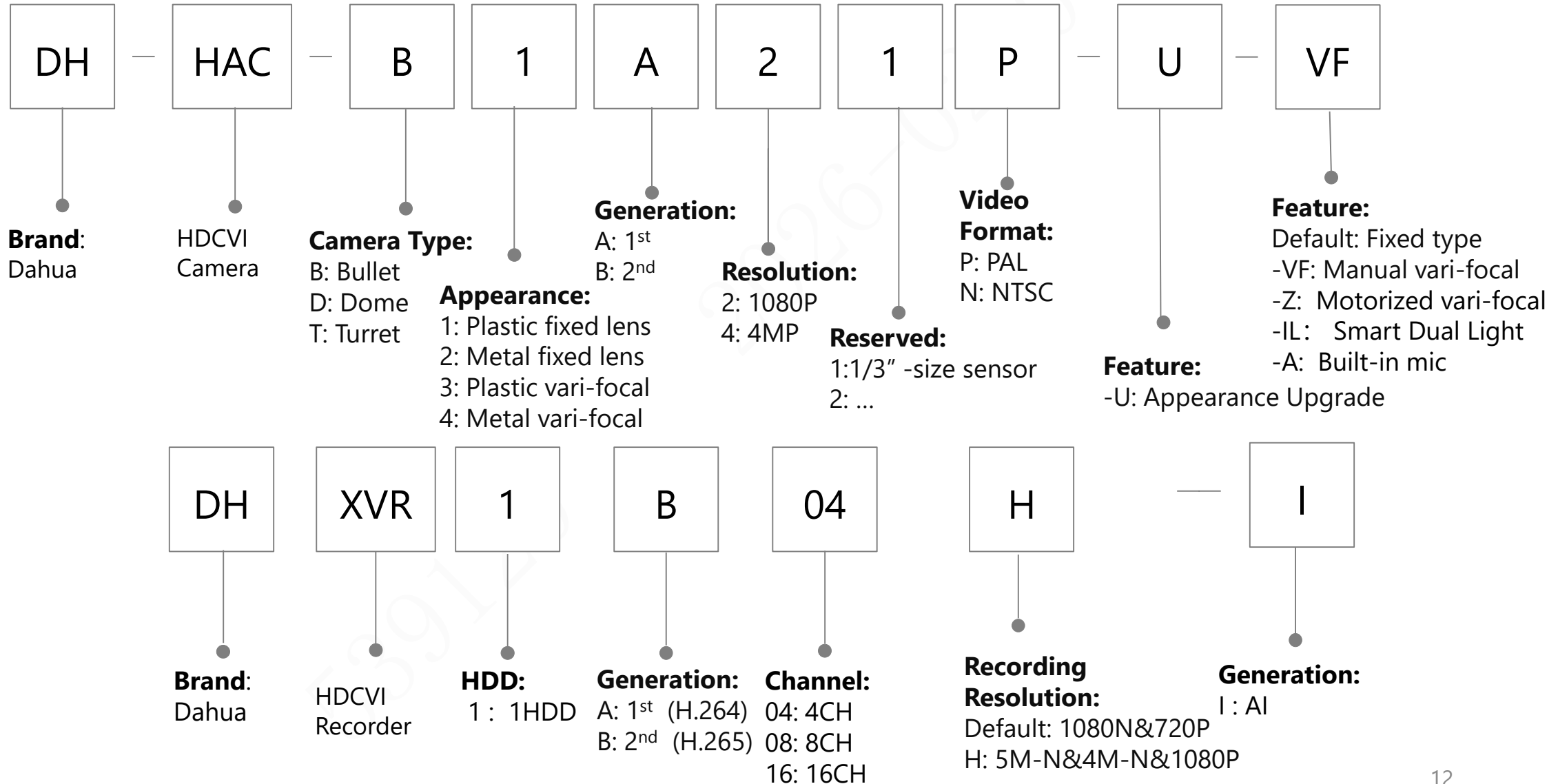

# PT Series

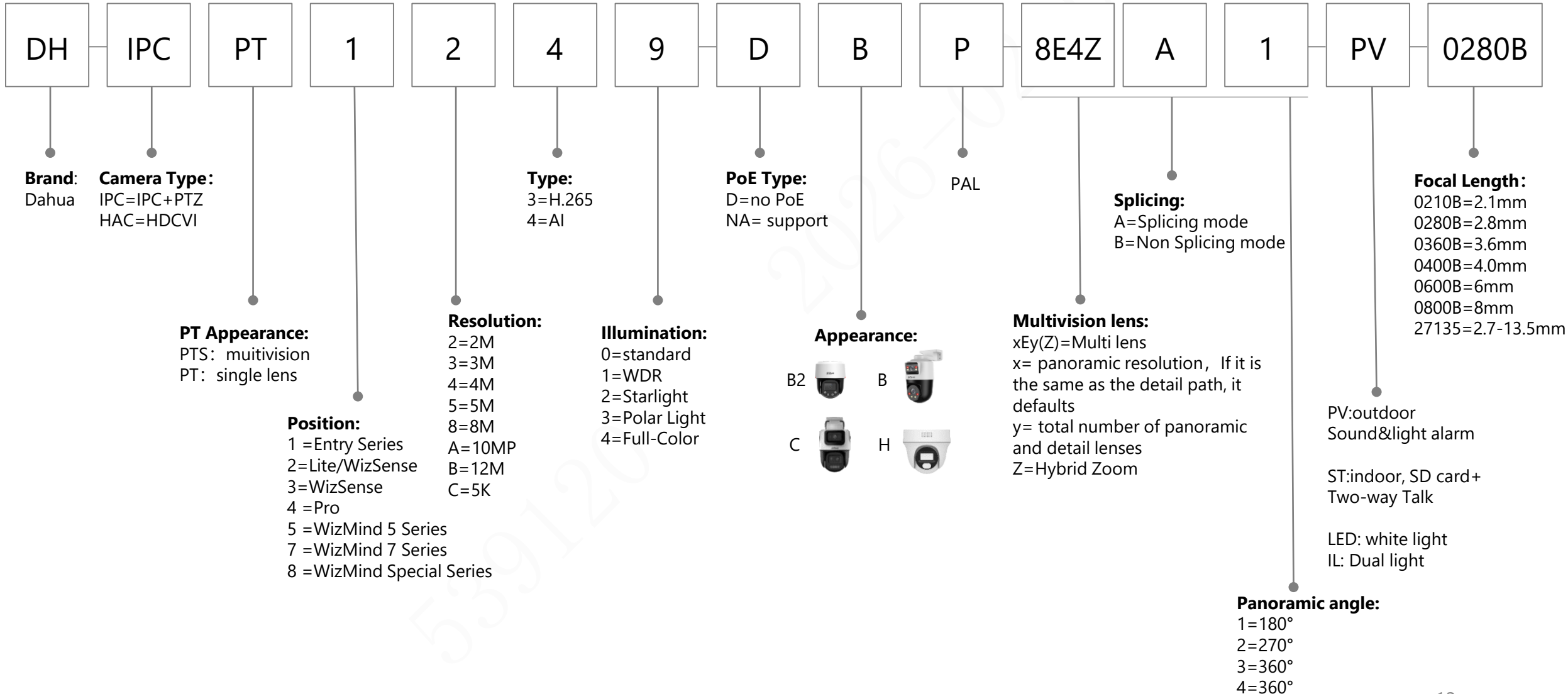

# Speed Dome

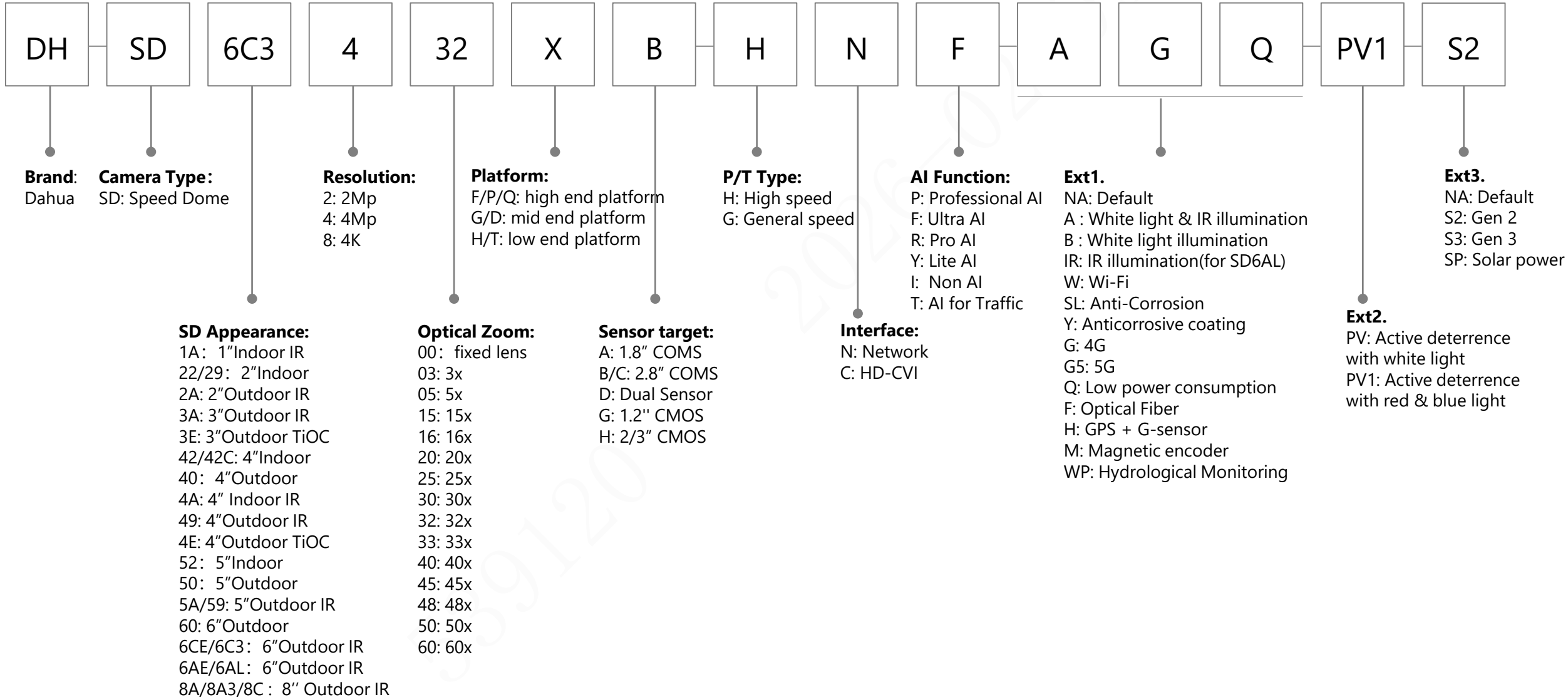

# PTZ/Explosion Series & Multi-sensor Series



PTZ: Positioning System  
ECA: Explosion camera

**Camera Type:**



H: High speed  
G: General speed  
**P/T Type:**

N: Network  
C: HD-CVI  
**Interface:**

F: Ultra AI  
R: Pro AI  
**AI Function:**

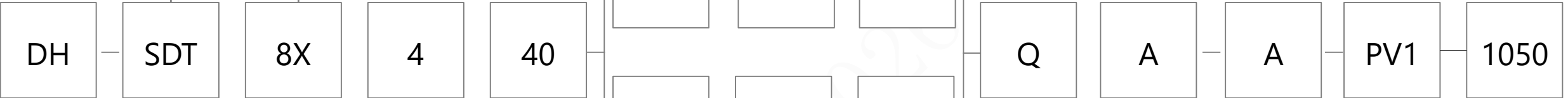

**Brand:**  
Dahua

**Camera Type:**  
SDT: Multi-sensor PTZ

**Resolution**  
2: 2Mp  
4: 4Mp  
5: 5Mp  
8: 4K

**Optical Zoom:**  
00: fixed lens  
03: 3x  
04: 4x  
12: 12x  
16: 16x  
25: 25x  
30: 30x  
31: 31x  
32: 32x  
33: 33x  
40: 40x  
45: 45x  
48: 48x  
50: 50x  
60: 60x

**Panorama Camera Feature**

**Resolution**  
2: 2Mp  
4: 4Mp  
5: 5Mp  
8: 4K

**Lens Type**  
Z: Zoom  
F: Fixed lens

**Optical Zoom:**  
4: 4x  
5: 5x

**Platform:**  
F/P/Q: high end platform  
G/D: mid end platform  
H/T: low end platform

**Ext1. (NA: Default)**  
A : White light & IR illumination  
B : White light illumination  
IR: IR illumination(for SD6AL)  
W: Wi-Fi  
SL: Anti-Corrosion  
Y: Anticorrosive coating  
G: 4G  
G5: 5G  
Q: Low power consumption  
F: Optical Fiber  
H: GPS + G-sensor  
M: Automatic Recovery of Position  
L: Laser  
JG: Traffic

**PTZ Camera Sensor Size:**  
A: 1/1.8"  
B: 1/2.8"  
C: 1/2.8"  
D: Dual-sensor  
F: 4/3"  
G: 1/1.2"  
H: 2/3"  
I: 1/2.9"

**Ext 2. (NA: Default)**  
PV: Active deterrence with white light  
PV1: Active deterrence with red & blue light

**Fixed Zoom:**  
0118=1.18mm  
0142=1.42mm  
0185=1.85mm  
0280=2.8mm  
0360=3.6mm  
0600=6mm  
0800=8mm  
1200=12mm  
1600=16mm  
2500=25mm

**Optical Zoom:**  
2712=2.7-12mm  
0722=7-22mm  
4747=4.7-47mm  
3711=3.7-11mm  
27135=2.7-13.5mm  
5364=5.3-64mm  
0735=7-35mm

**SDT Appearance**



# Interactive Whiteboards



DeepHub Interactive Display External Model Naming Rule

	Required	Required	Required	Required	Required		Required	Required	Required	Required	Required	Optional	Required				
Field number	①	②	③	④	⑤		⑥	⑦	⑧	⑨	⑩	⑪	⑫				
Identification	Dahua identifier	Product line identifier	Sales Type	Product Form Factor	Size label		Market positioning	Camera	Series Identifier 2	Chip Model	Touch input method	Series positioning	Iteration Version				
Instance	DH	-	L	C	H	-	86	-	S	T	4	0	0	-	U	-	S2
DeepHub Interactive Display Explanation	DH= Dahua brand DHI= Overseas Dahua brand N= Domestic neutral Default= Overseas neutral	L= LCD all-in-one machine E=LED all-in-one machine	C: Channel-oriented P: Project-oriented E: E-commerce	H: Landscape V: Portrait	55=Dimension 55 inches 65=Dimension 65 inches 75=Dimension 75 inches 85=Dimension 85 inches 86=Dimension 86 inches 98=Dimension 98 inches 110=Dimension 110 inches 138=Dimension 138 inches		S=Education H=Smart Blackboard M=Conference	T: No camera C: With camera	4=4K 8=8K	0~1: Basic model 2~5: Mid-range 6~7: High-end 8~9: Flagship	0: Infrared Zero Lamination 1: Capacitance Full Lamination 2: Capacitance Frame Lamination 3: Capacitance Zero Lamination 4: Infrared Frame Lamination 6: Infrared Full Lamination	U: Ultimate P: Professional/Pro C: Classic B: Basic L: lite/Lite+	Empty: First generation S2: Second generation S3: Third generation ...				
Typical example	DH-LCH86-ST400-U																

# Video Conferencing

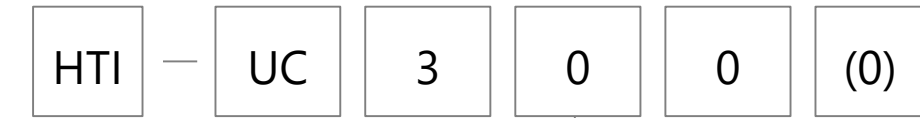

USB Camera

**Category:**

- 00-economical 1080P webcam
- 20-1080P USB webcam
- 25-1080P USB webcam (AF)
- 80H-4K webcam
- 90-4K webcam



Video conferencing system series

Microphone 3x: economical series  
4x: elite series



headset

**Category:**  
2-medium



Video conferencing system series

All-in-one USB camera & PTZ camera & HD camera

- 4- All-in-one USB camera (set on table)
- 5- Soundbar & (PTZ camera)



Video conferencing system series

Endpoint



Video conferencing Multiple control unit



Video conferencing system series

IP Speaker Series of products

Hor n

# Accessory

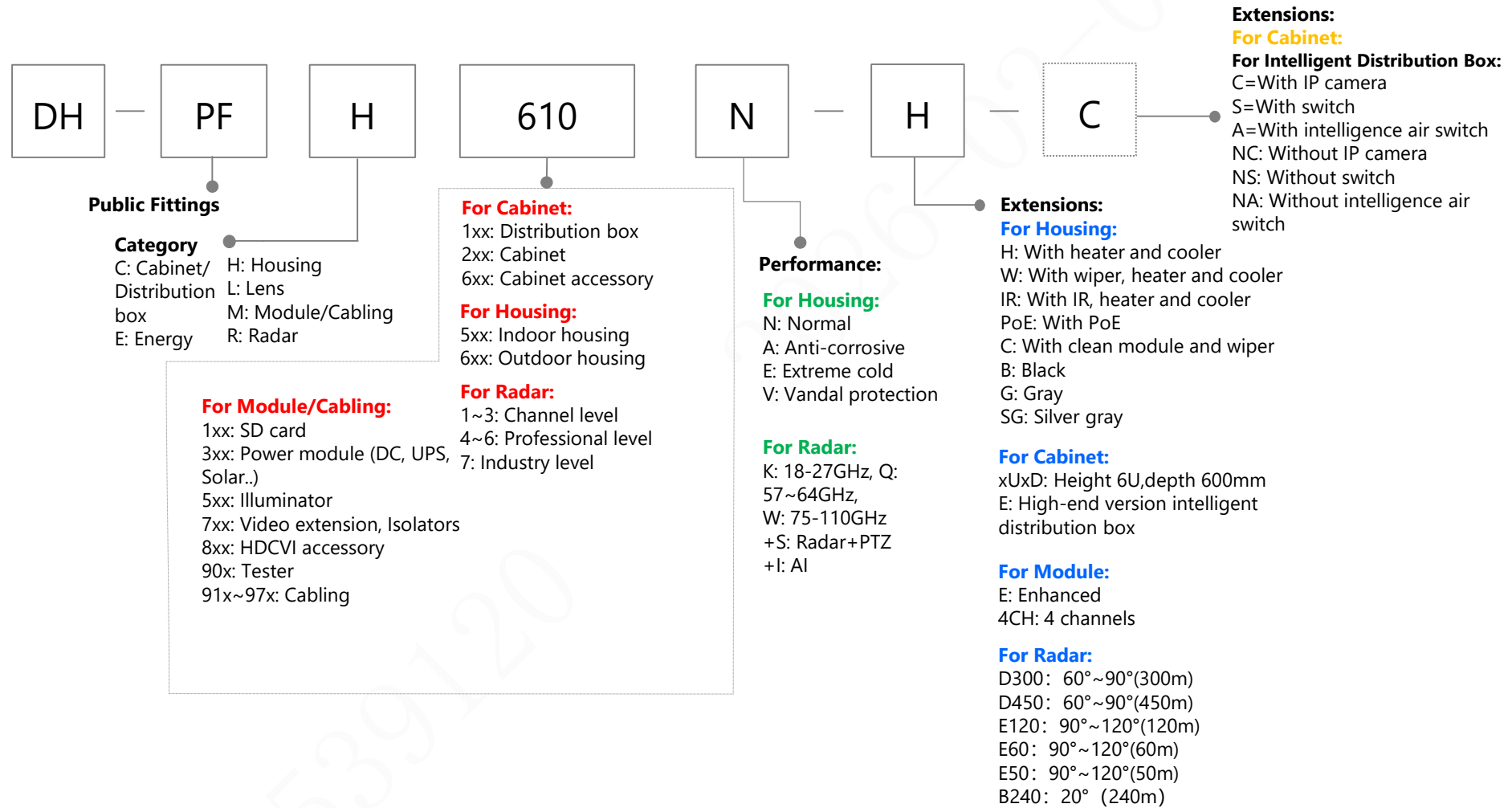

# Accessory-Camera mount

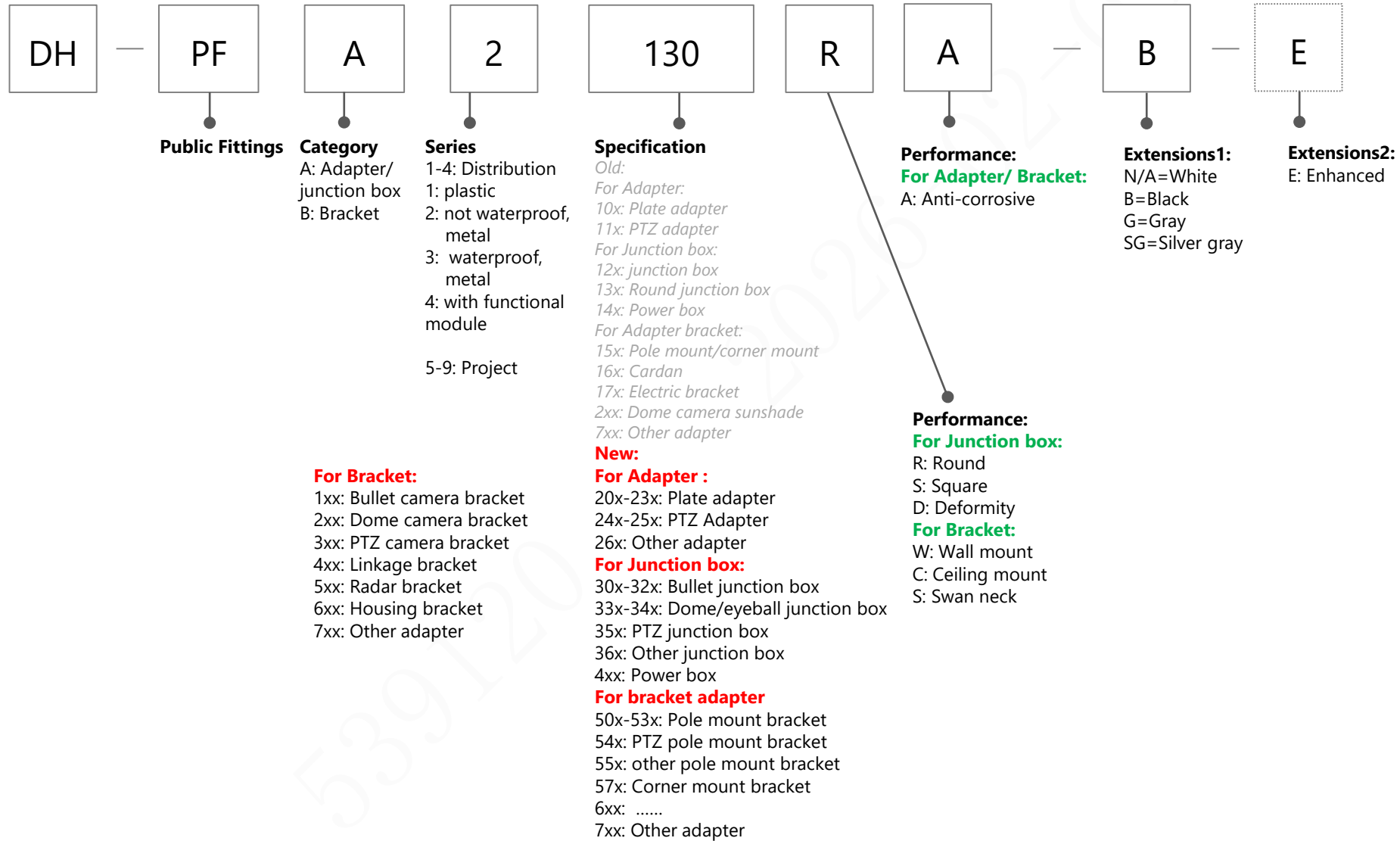

# Accessory-Lens

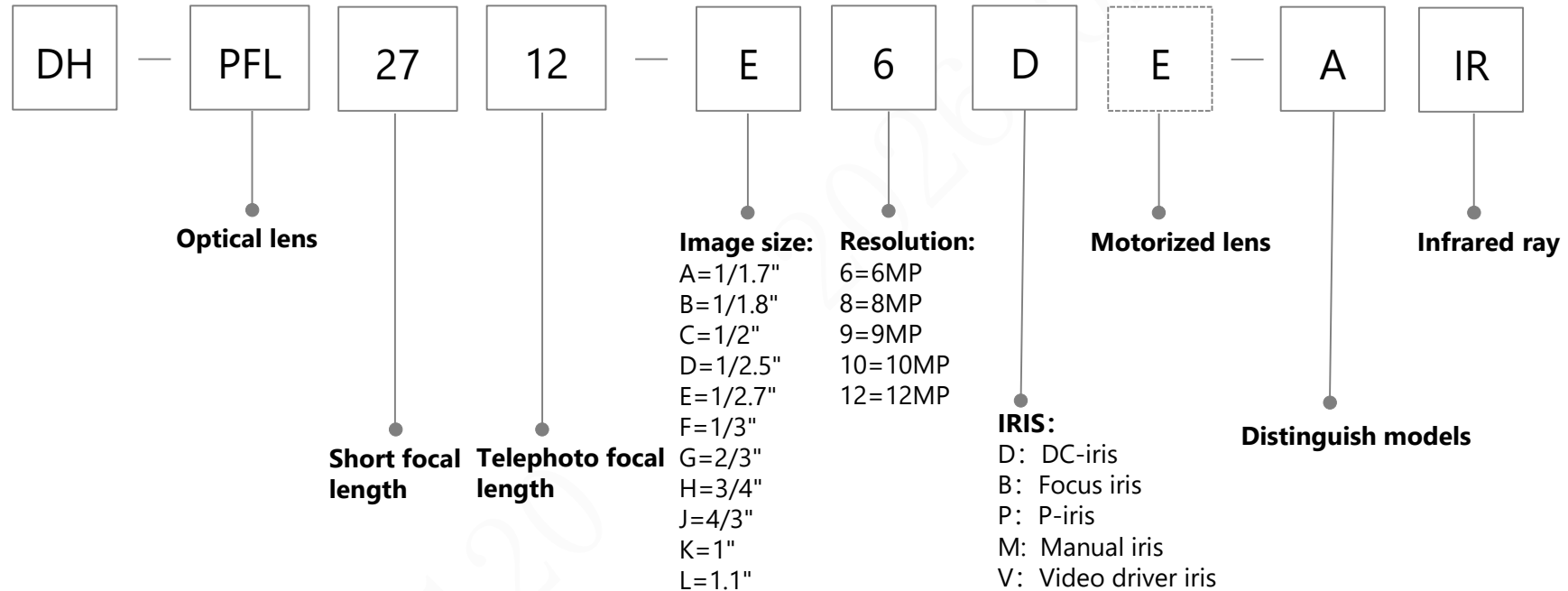

# Accessory-power

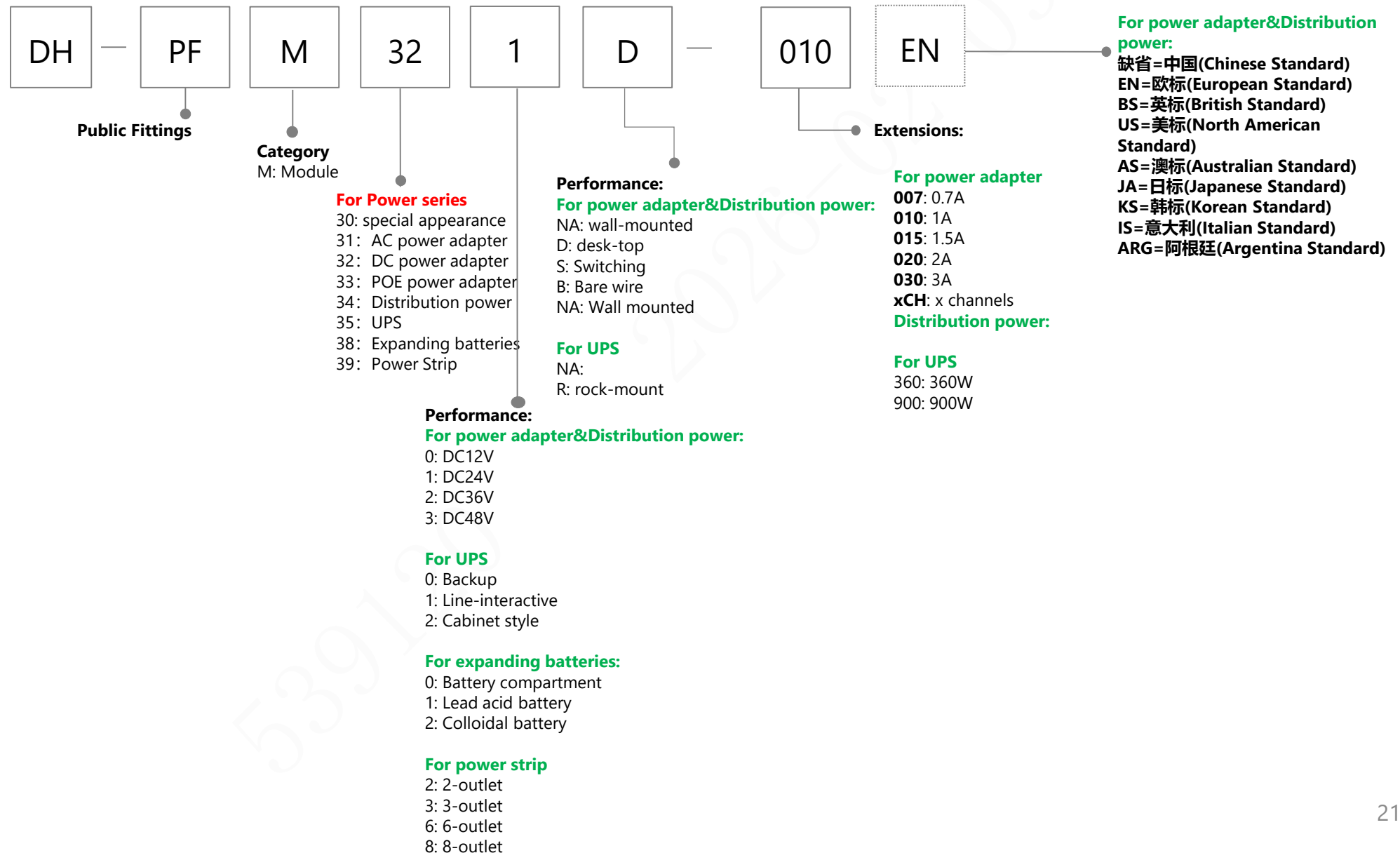

# Accessory-Cabling

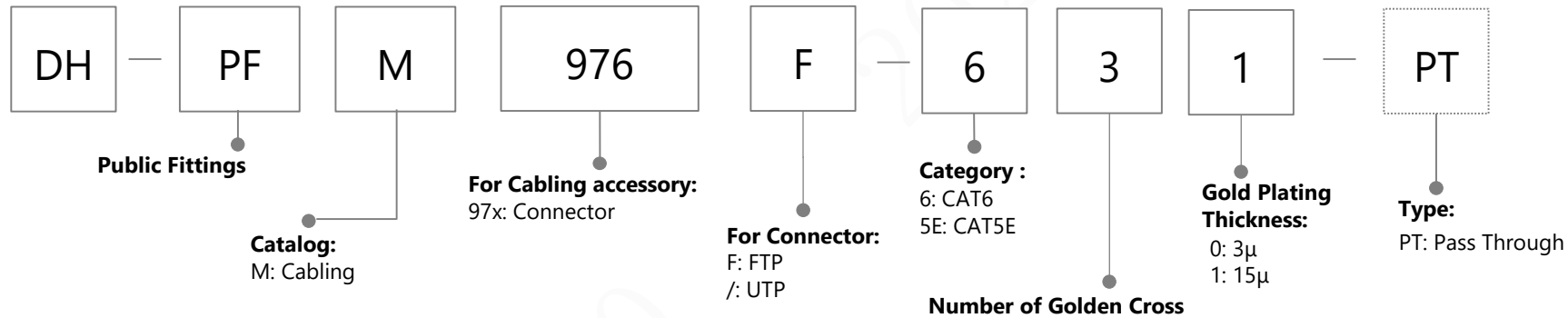
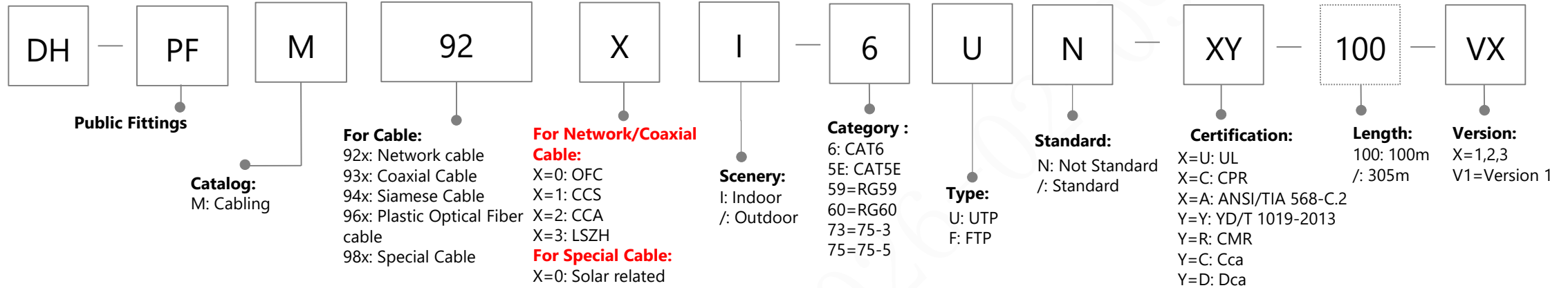

## General Cabling-Network Cable

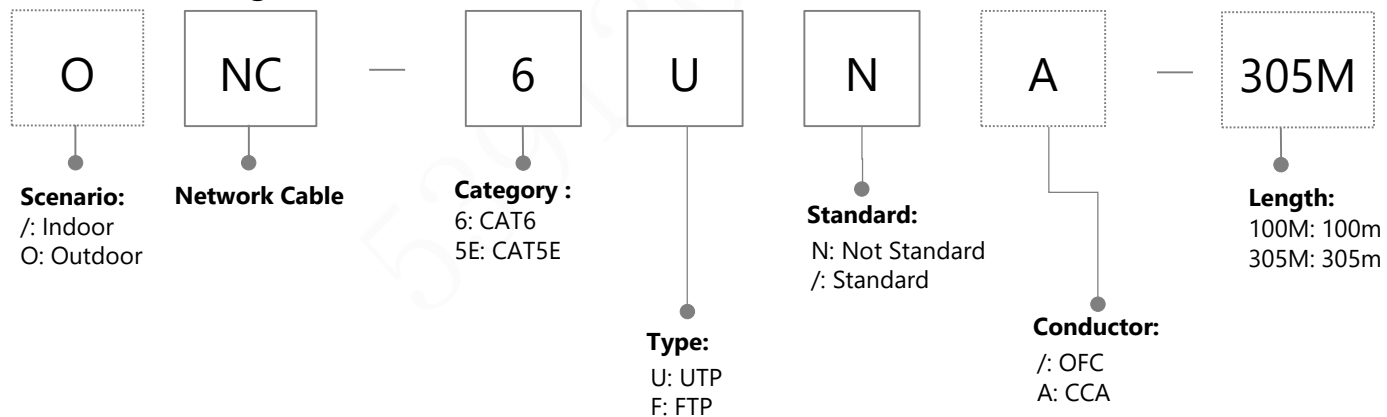

# Accessory-Cabling

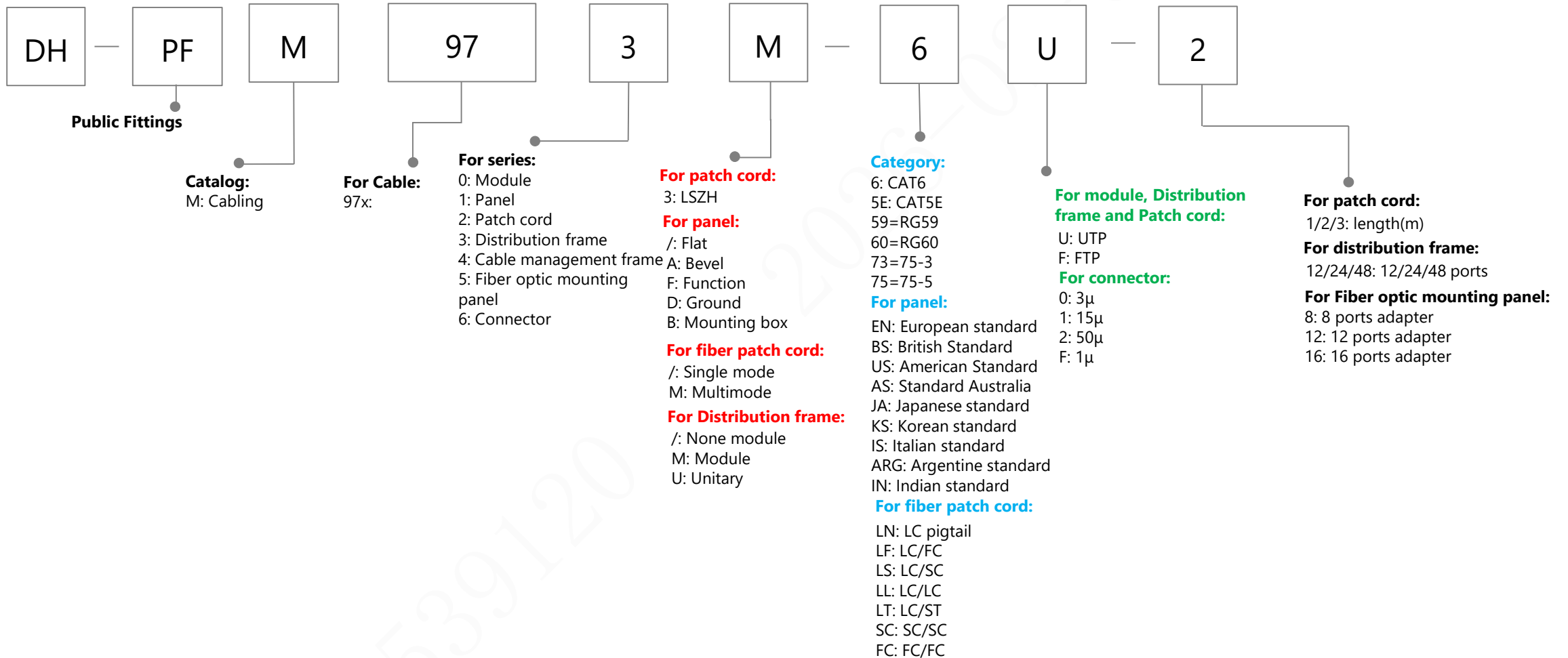

# Accessory-Solar

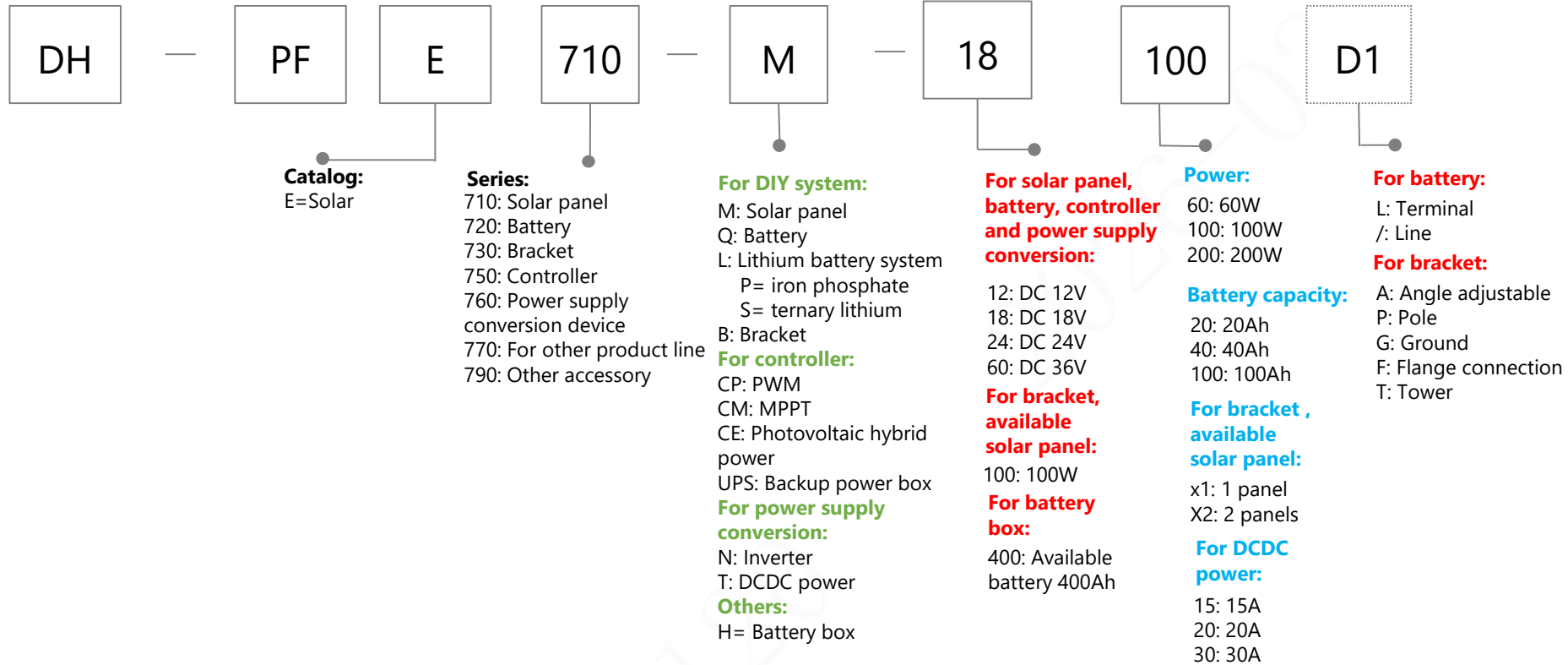

# Accessory-Solar

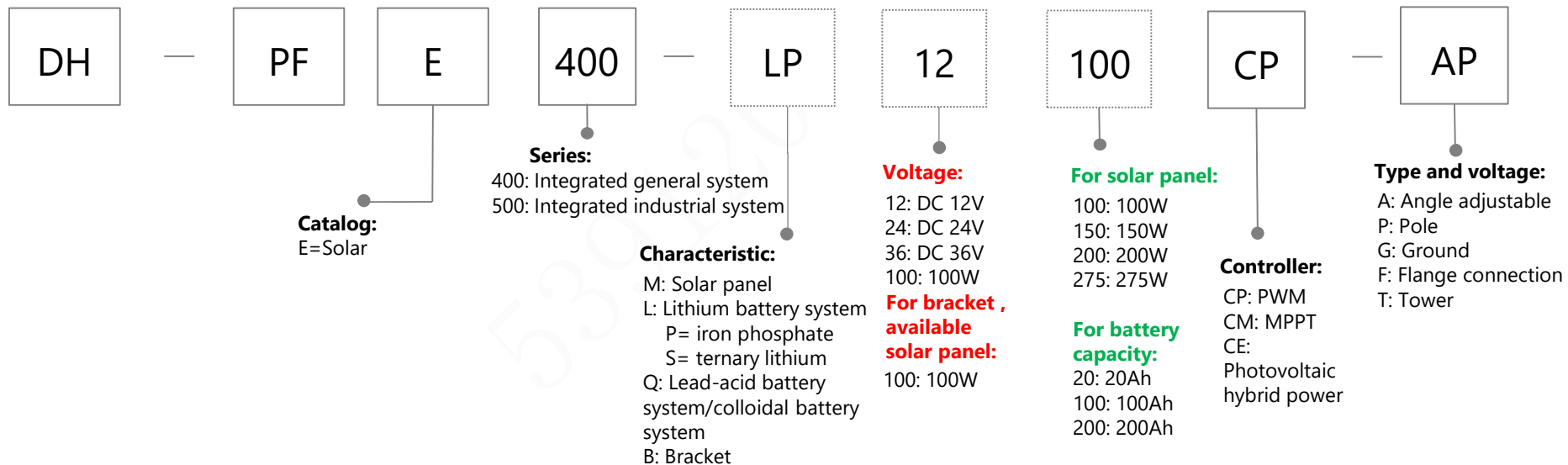
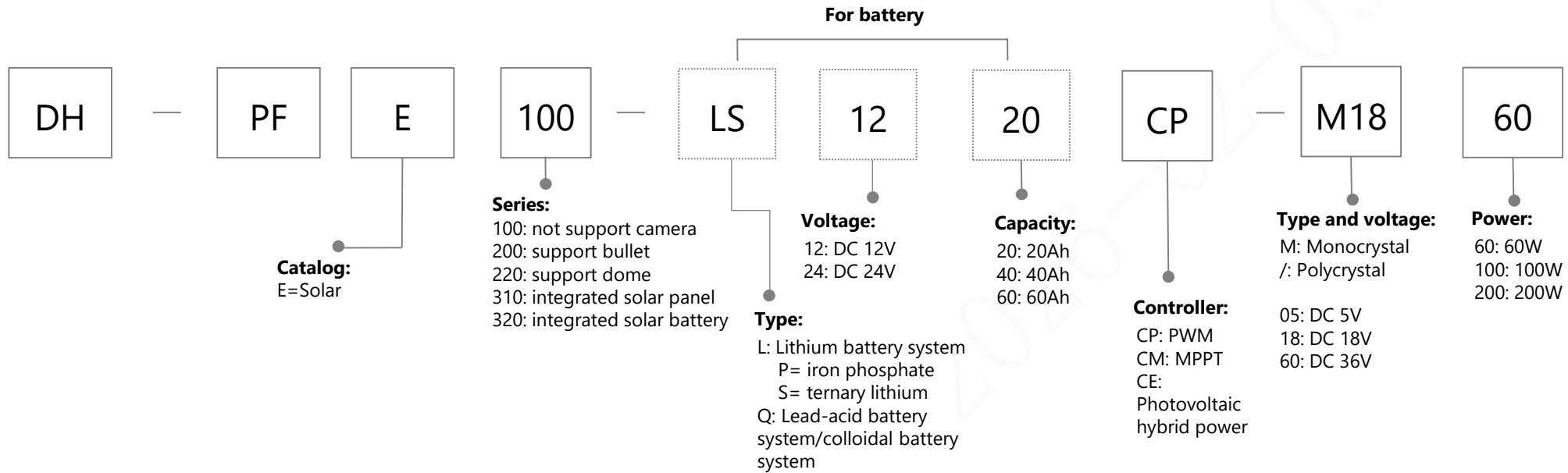

# General NVR

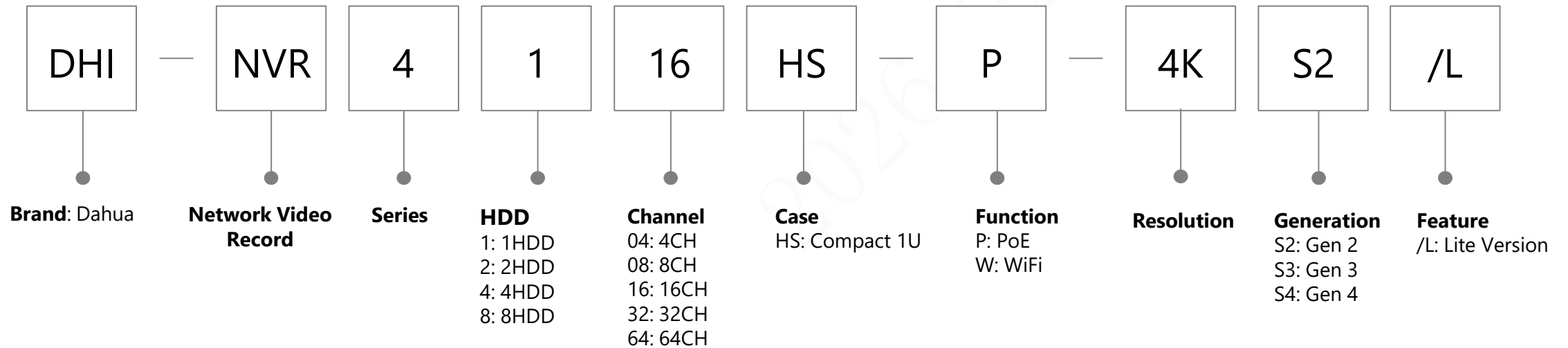

# AI NVR

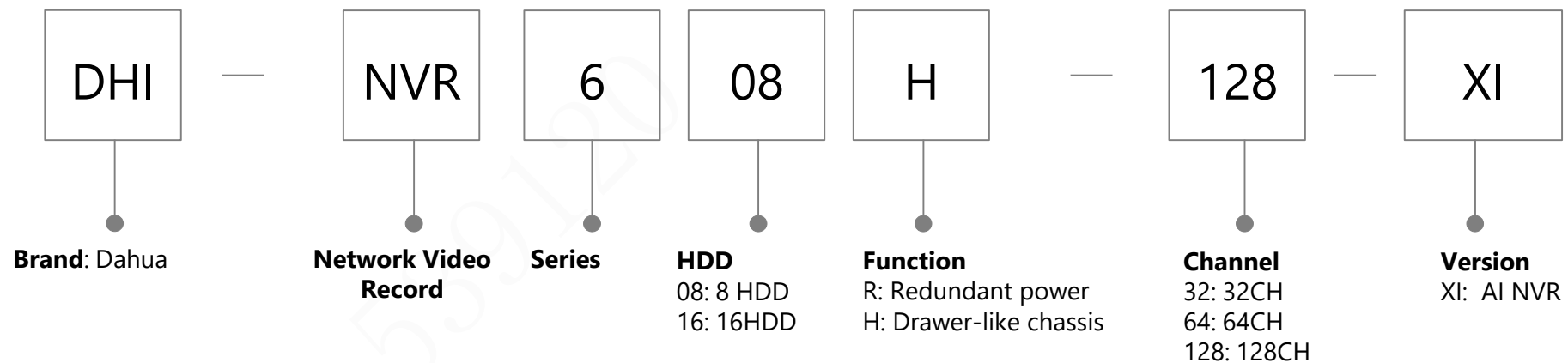
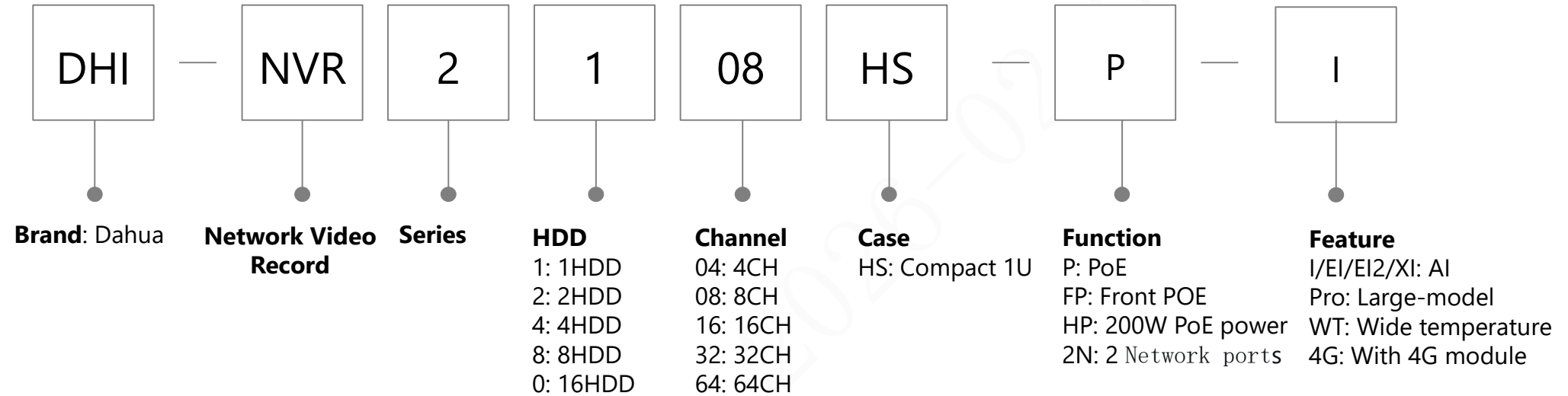

# NVR KIT

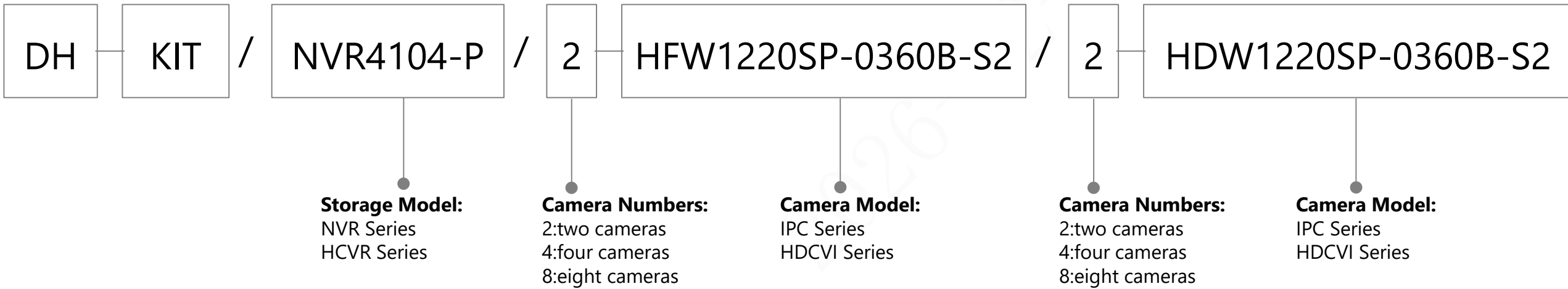

# HDCVI Recorder (XVR)

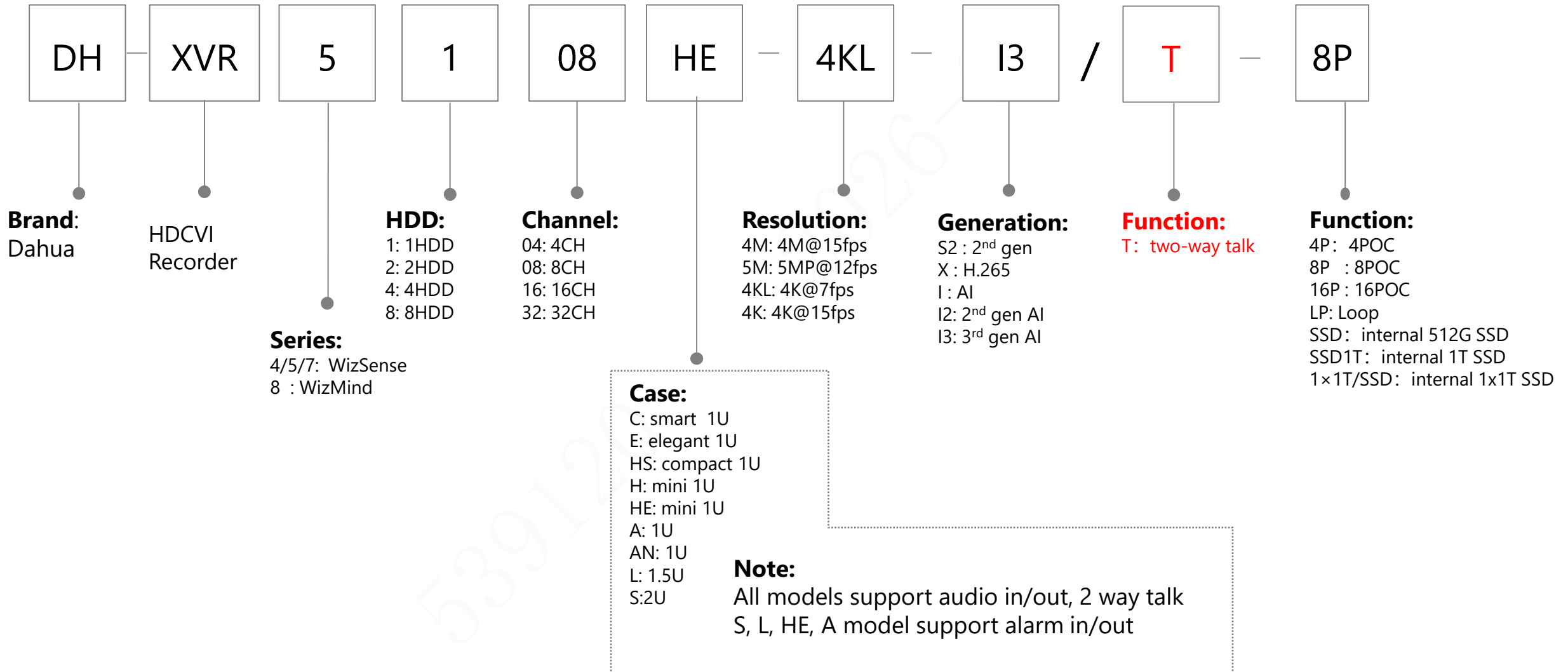

# HDCVI Cooper Series (Recorder)

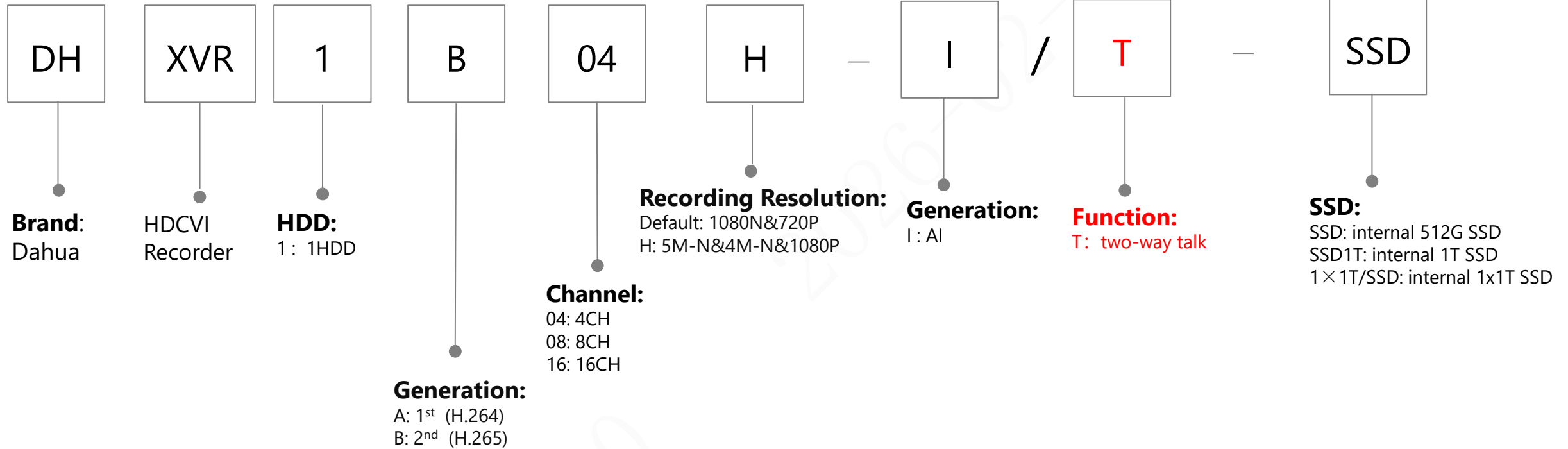

# XVR KIT

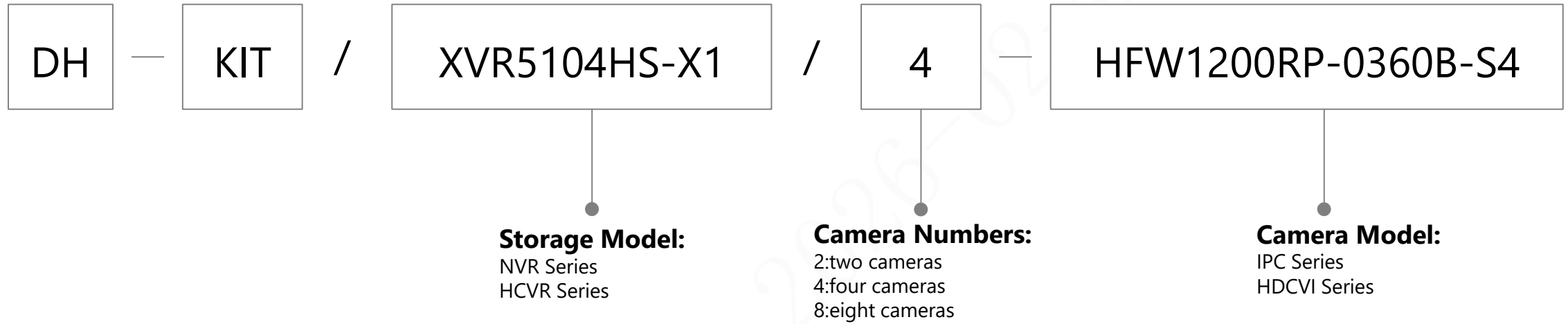

# ATM DVR/NVR

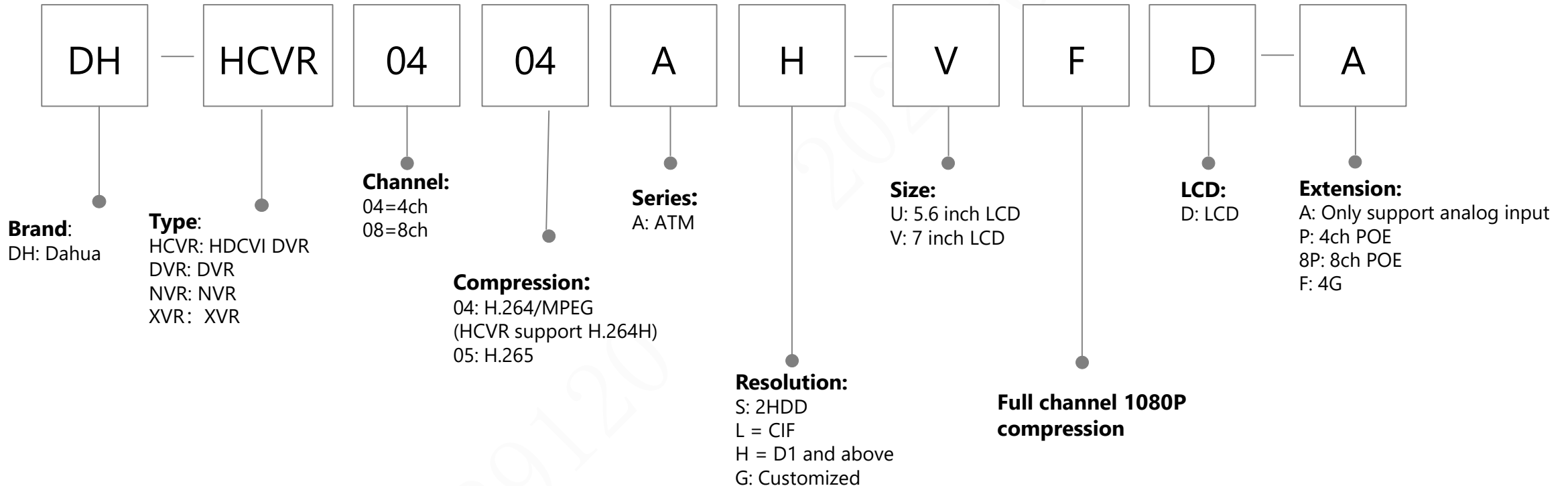

# IVSS & IVD

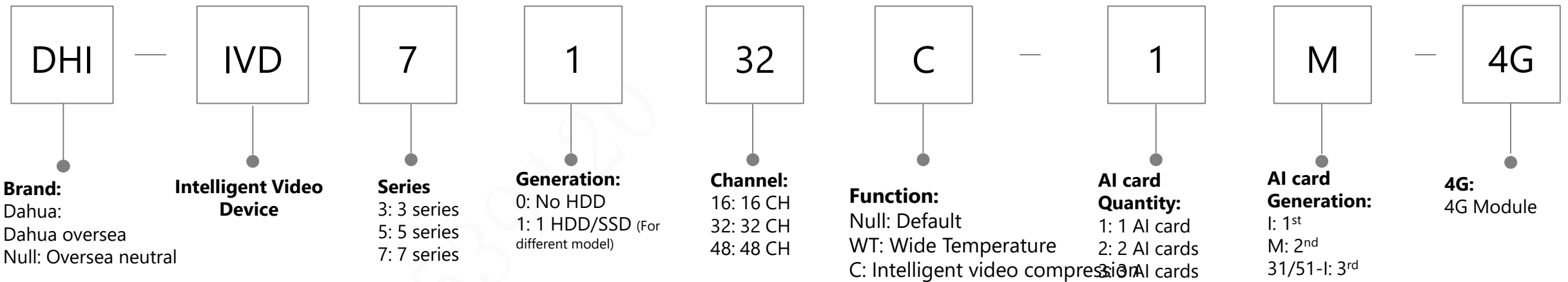
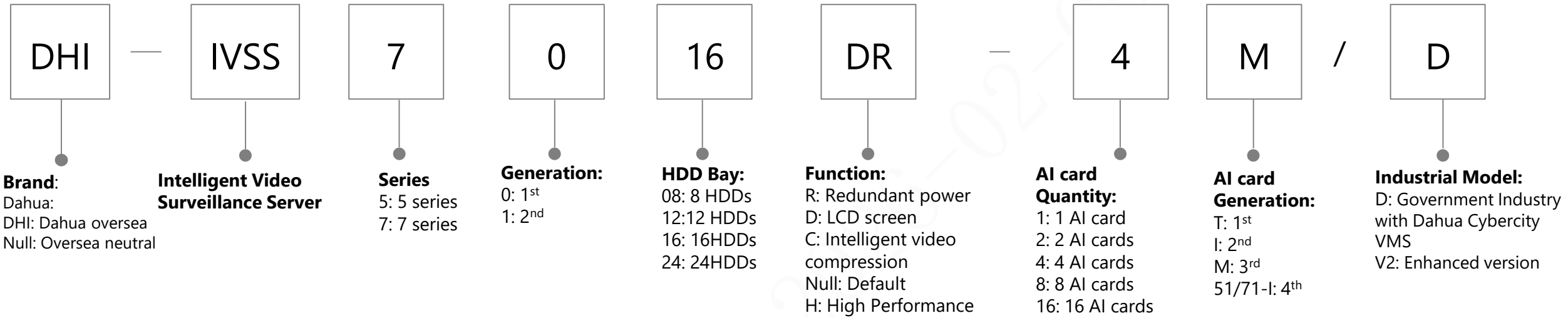

# EVS & ESS

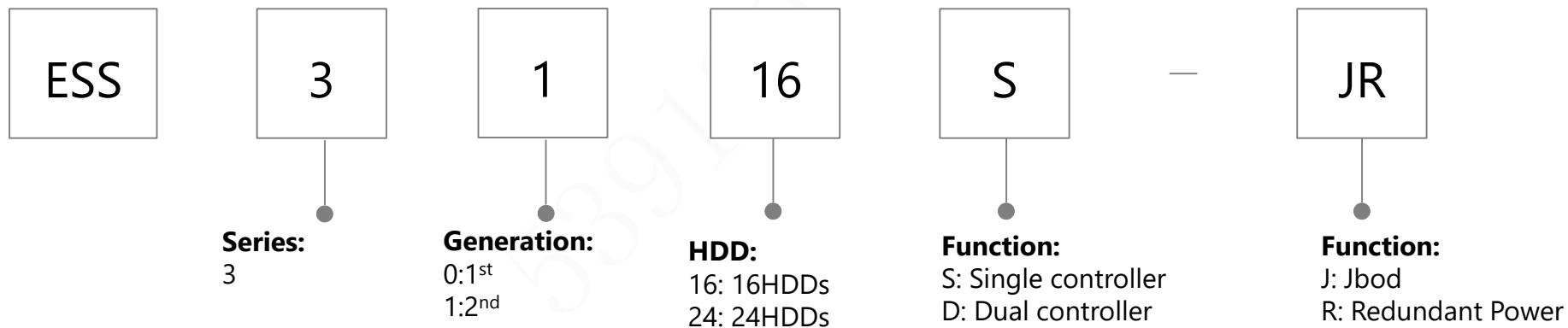
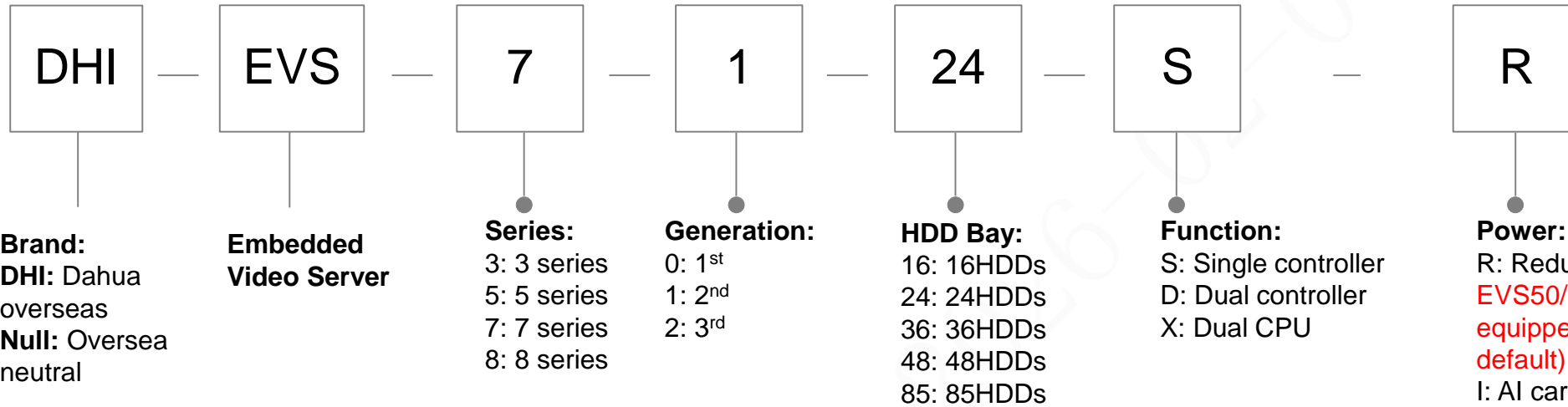

# IVS

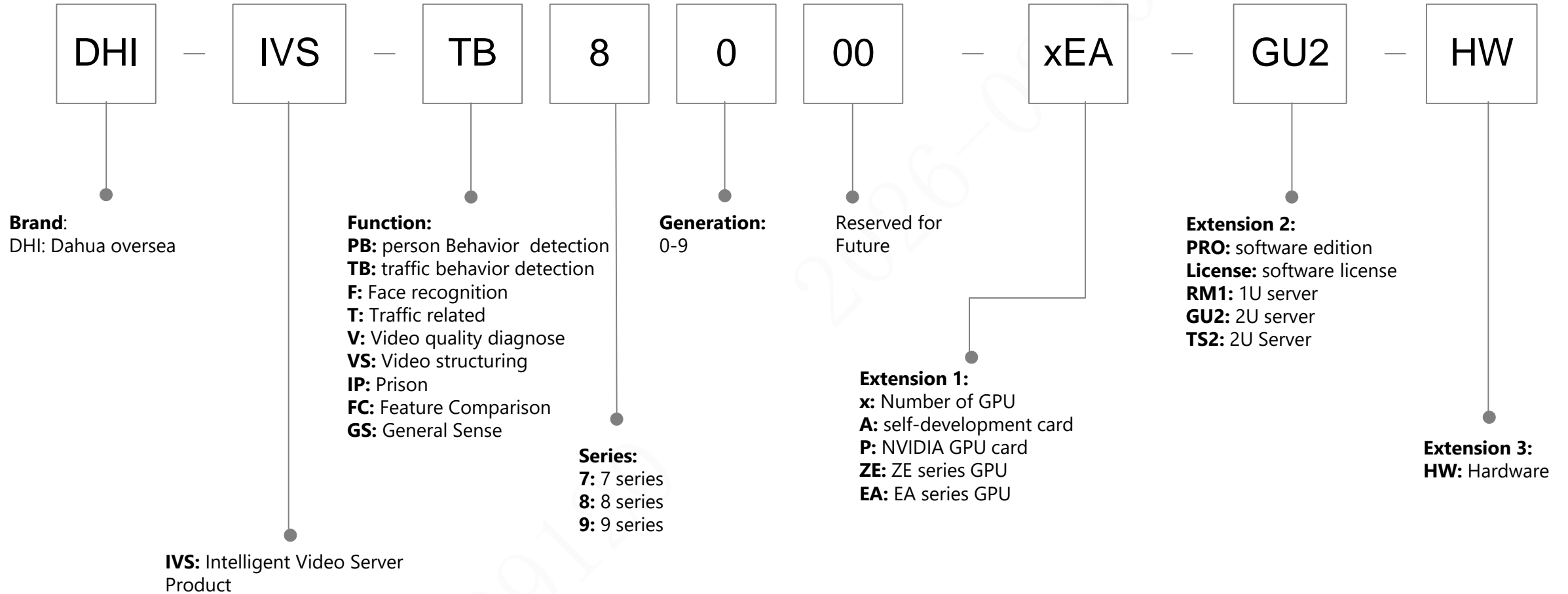

# Switch

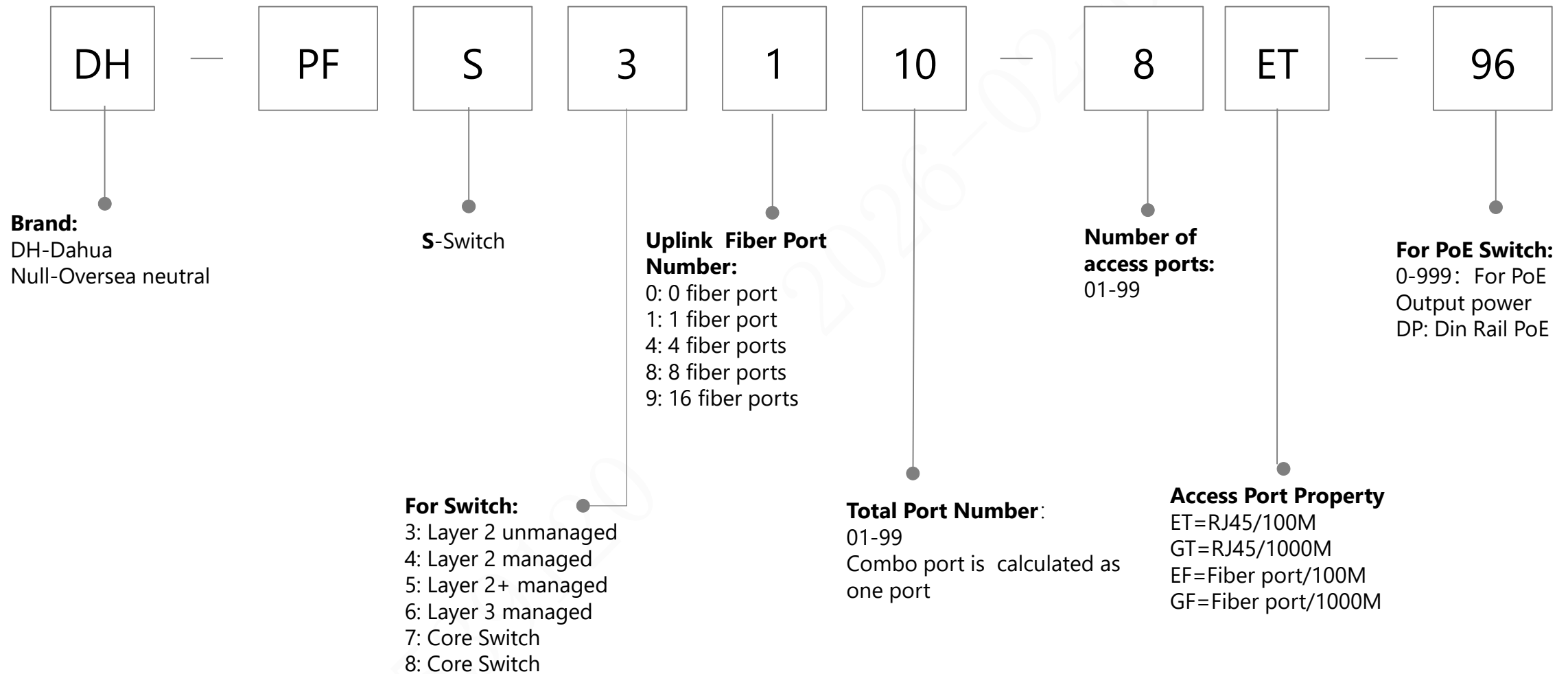

# Switch(new,CCTV)

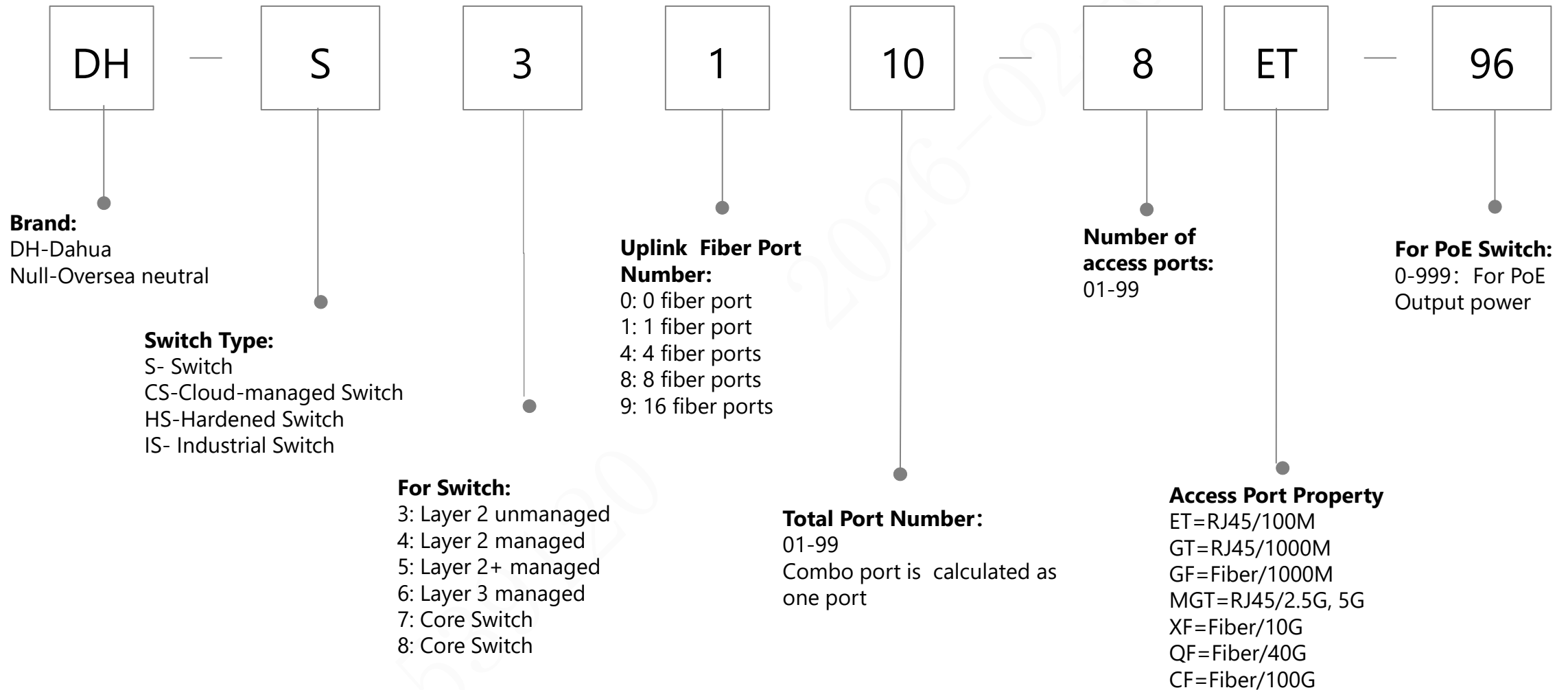

# Switch(new, IT)

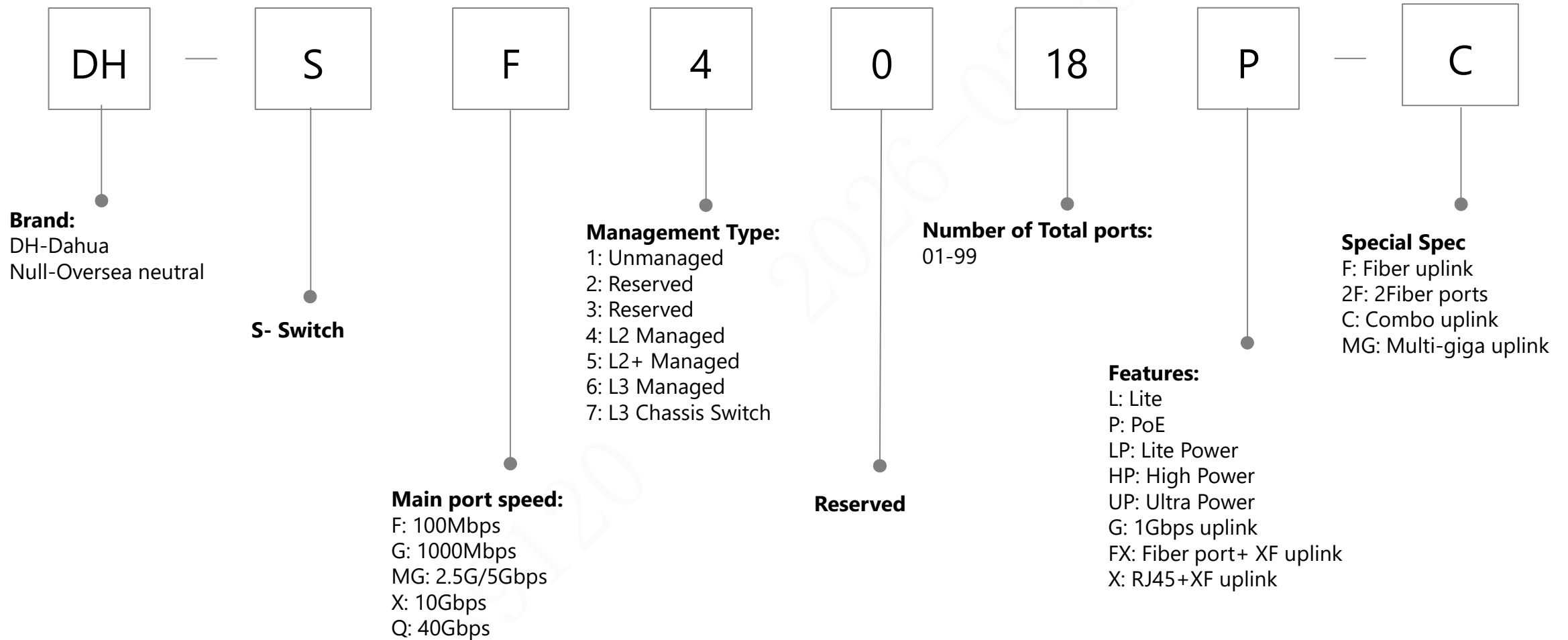

# Wireless Router

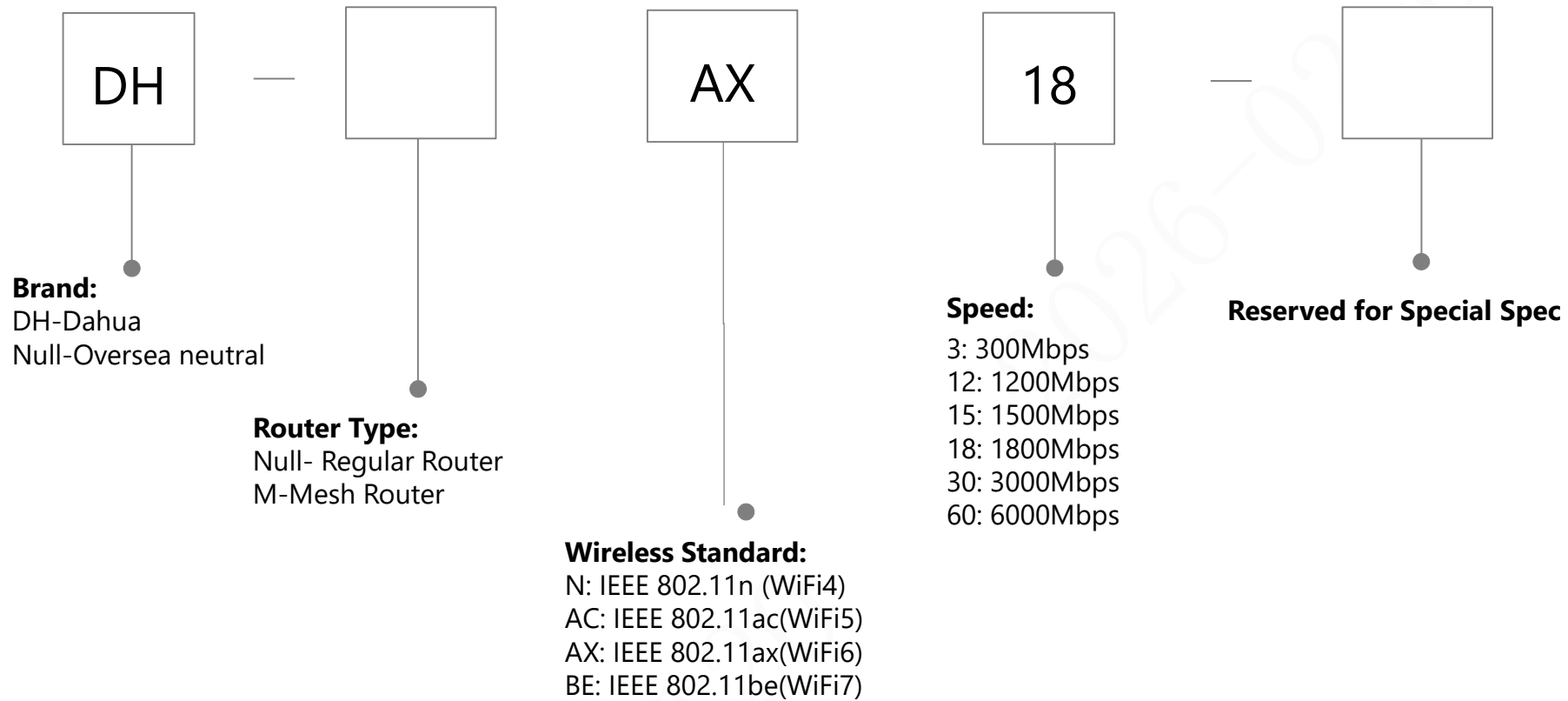

# Wireless Bridge (Only for V-Radio series wireless bridge)

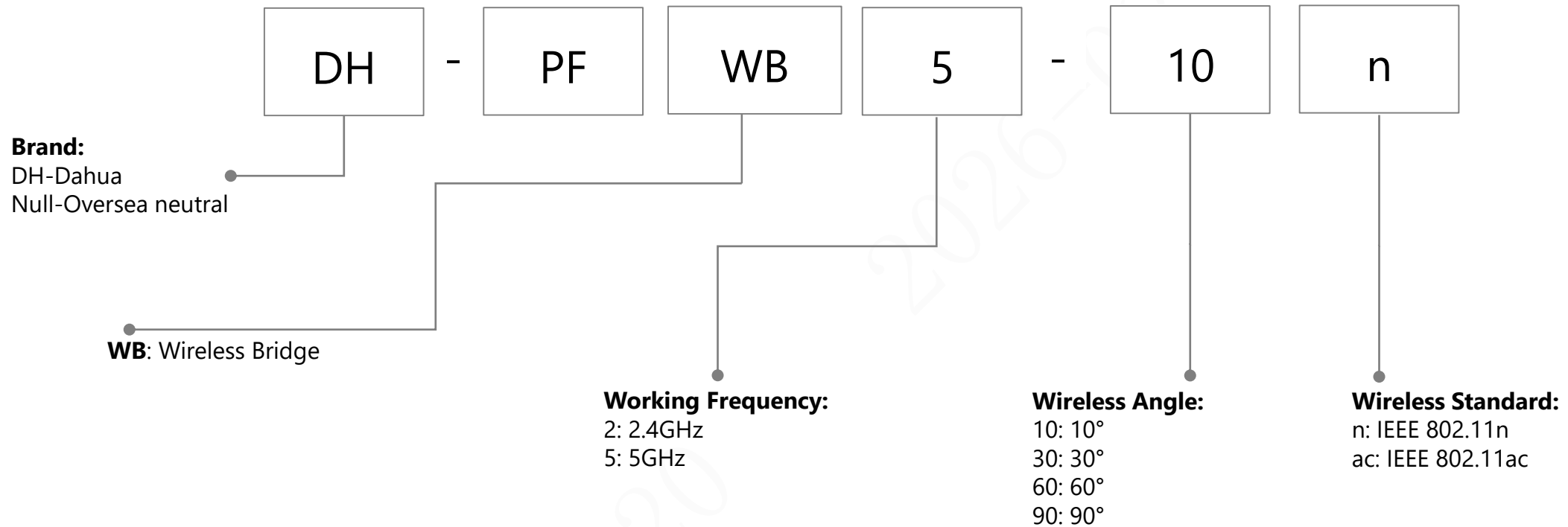

# Wireless Bridge(new)

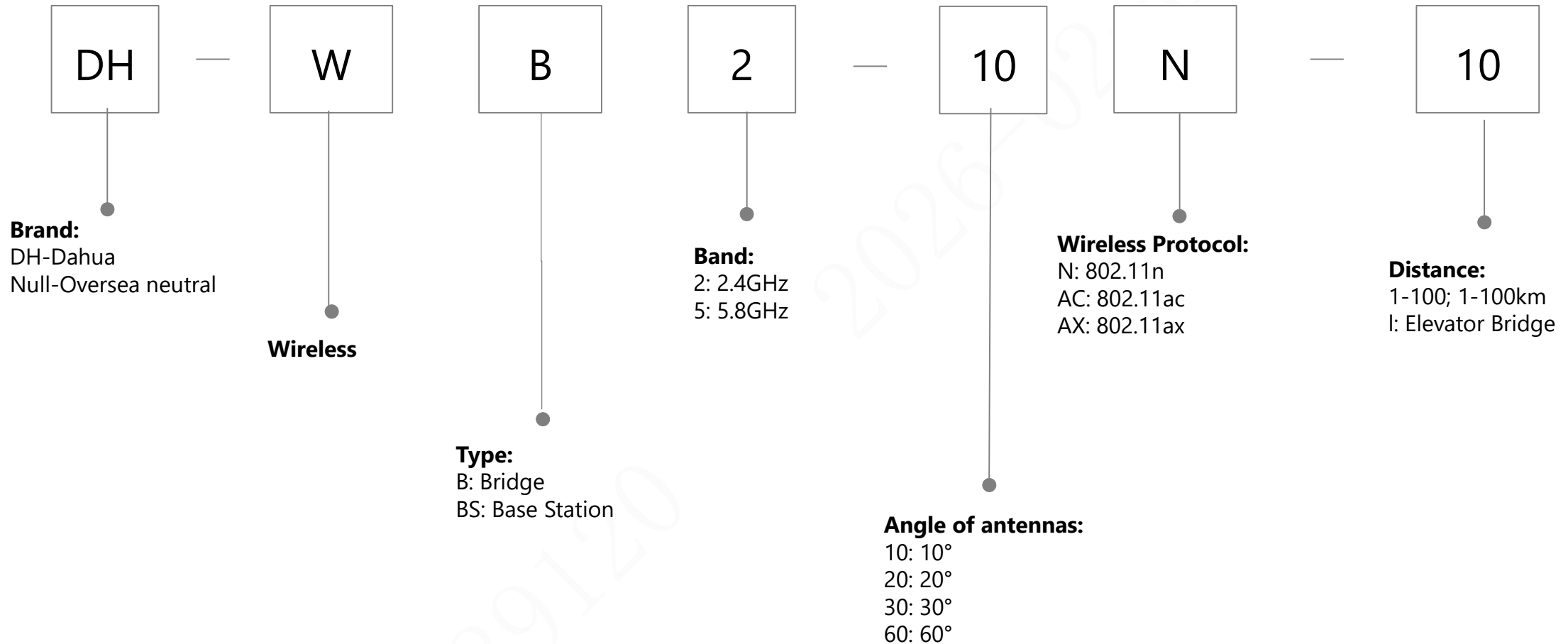

# AP

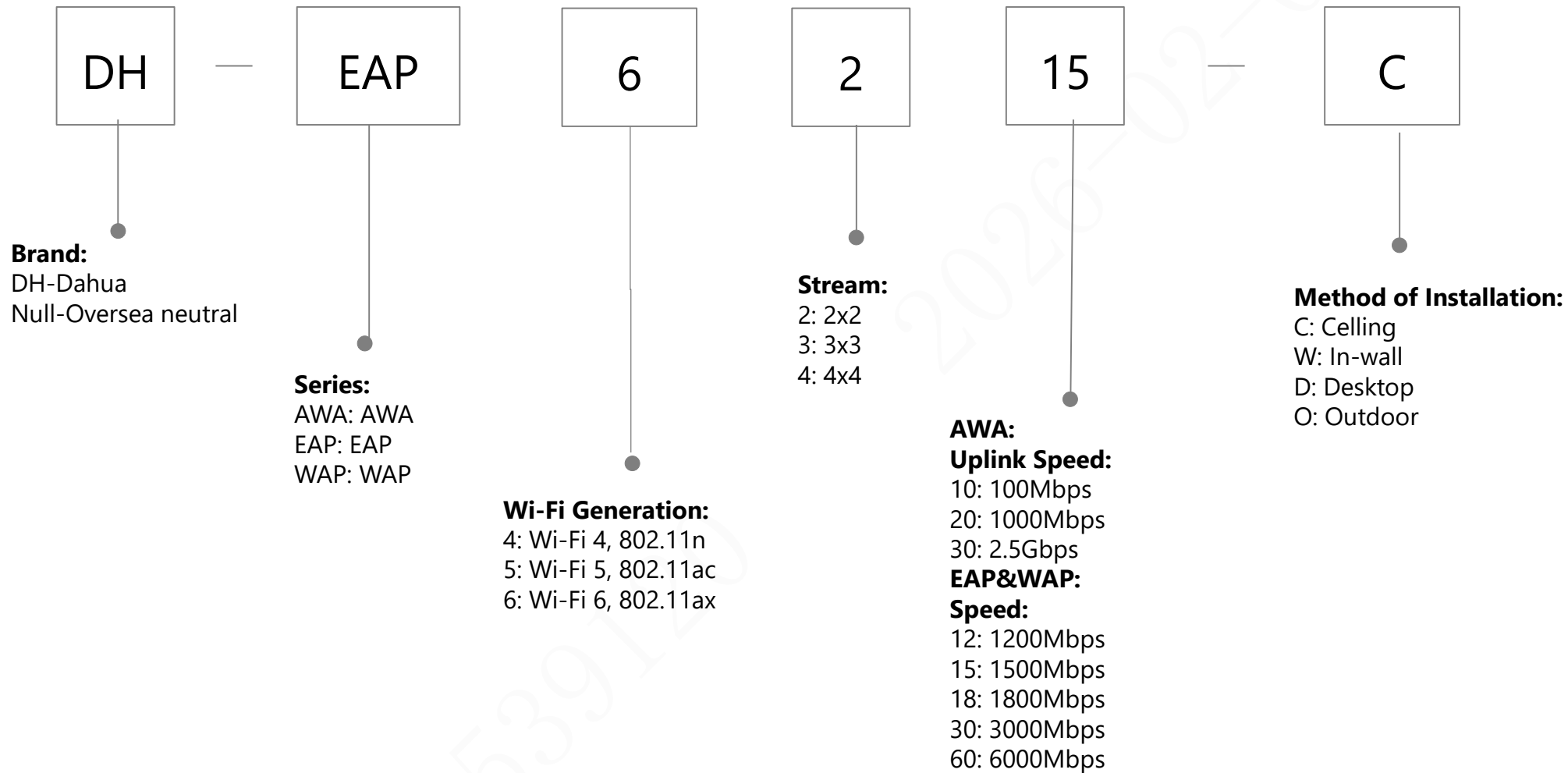

# MPT

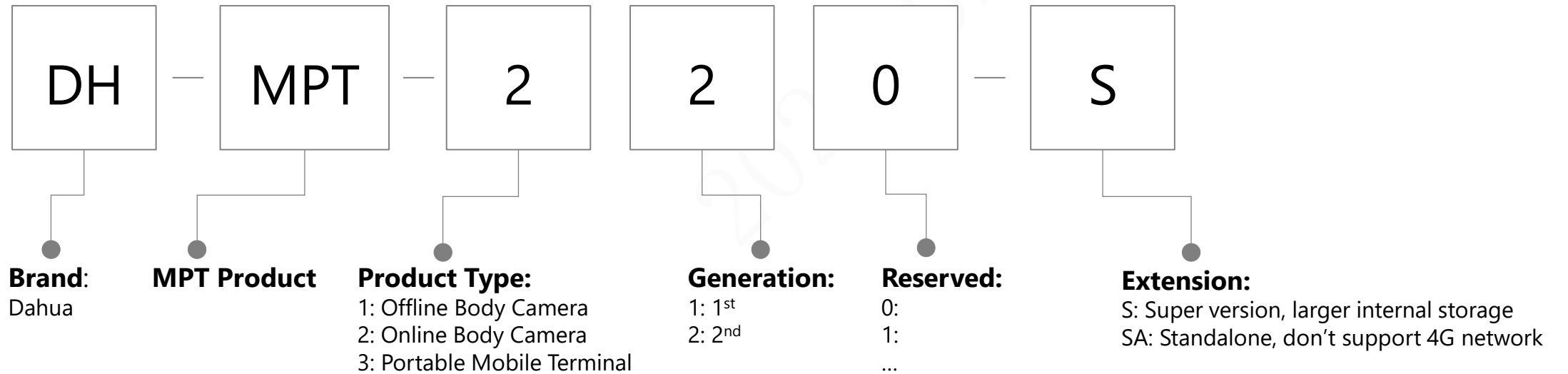

# MPT

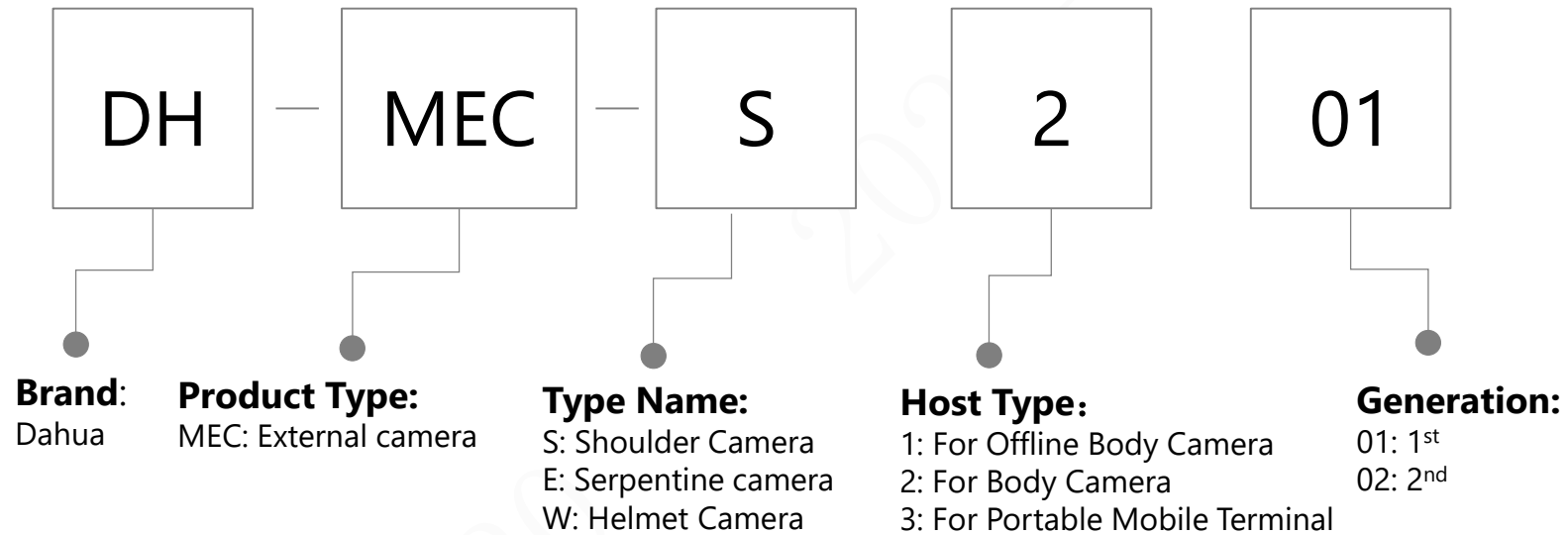

# MPT

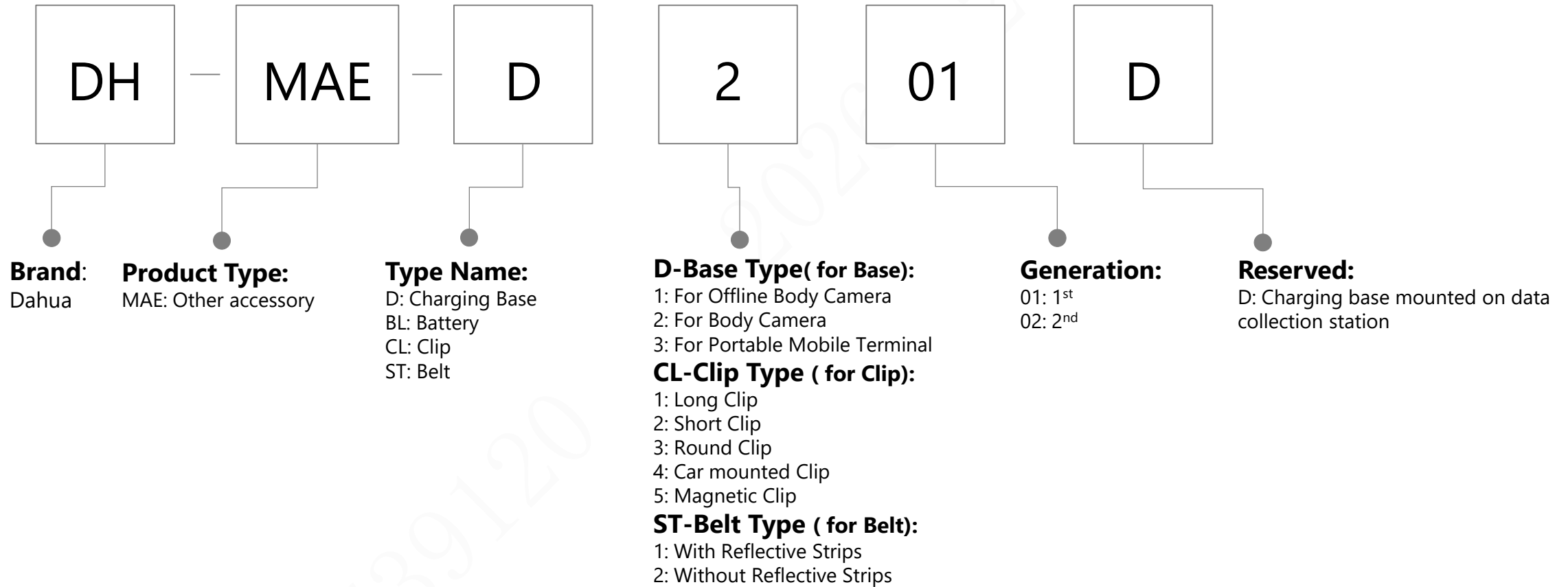

# DSS Baseline

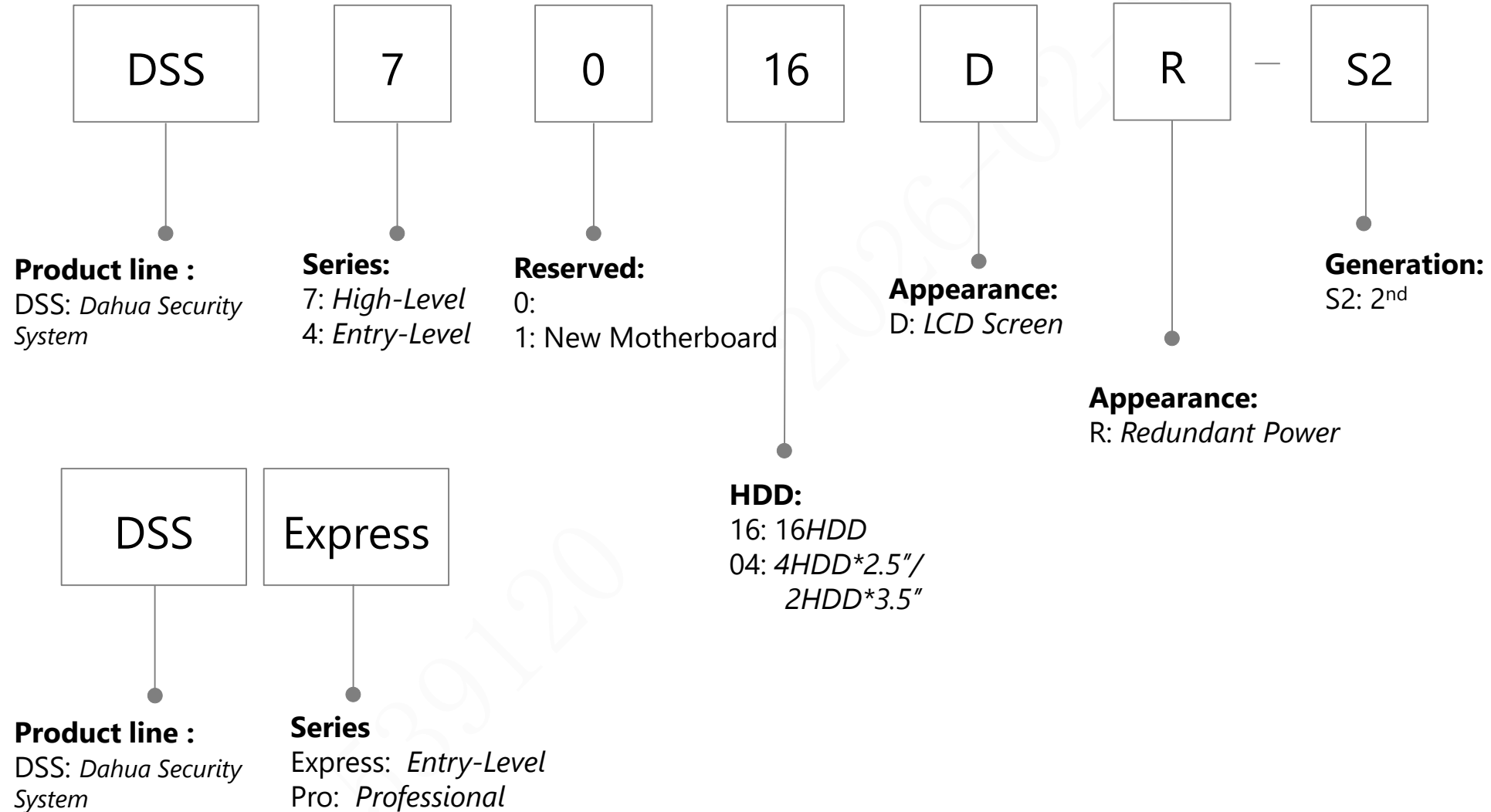

# Video Intercom(Door Station)



**Notice:** The naming rule is applicable to the products released after 2016

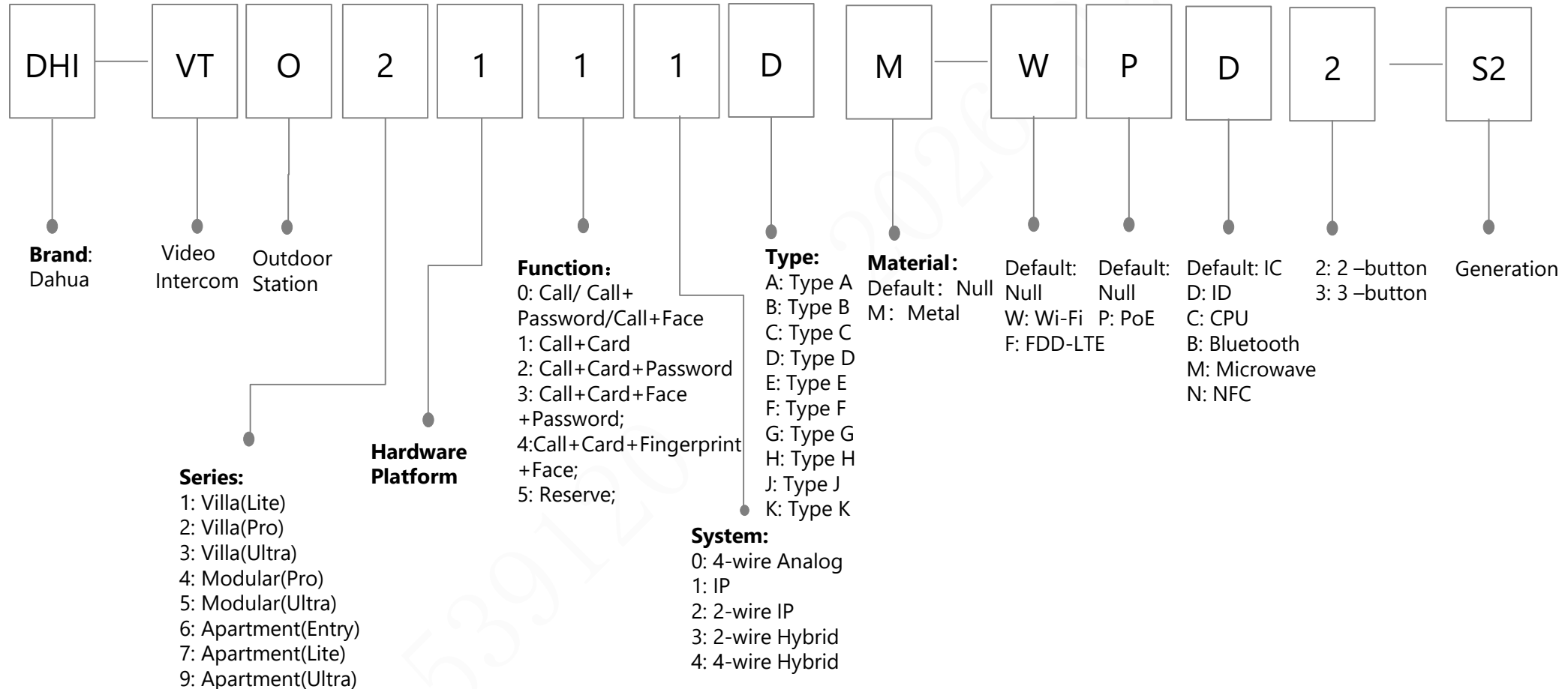

# Video Intercom(Indoor Monitor)



**Notice:** The naming rule is applicable to the products released after 2016

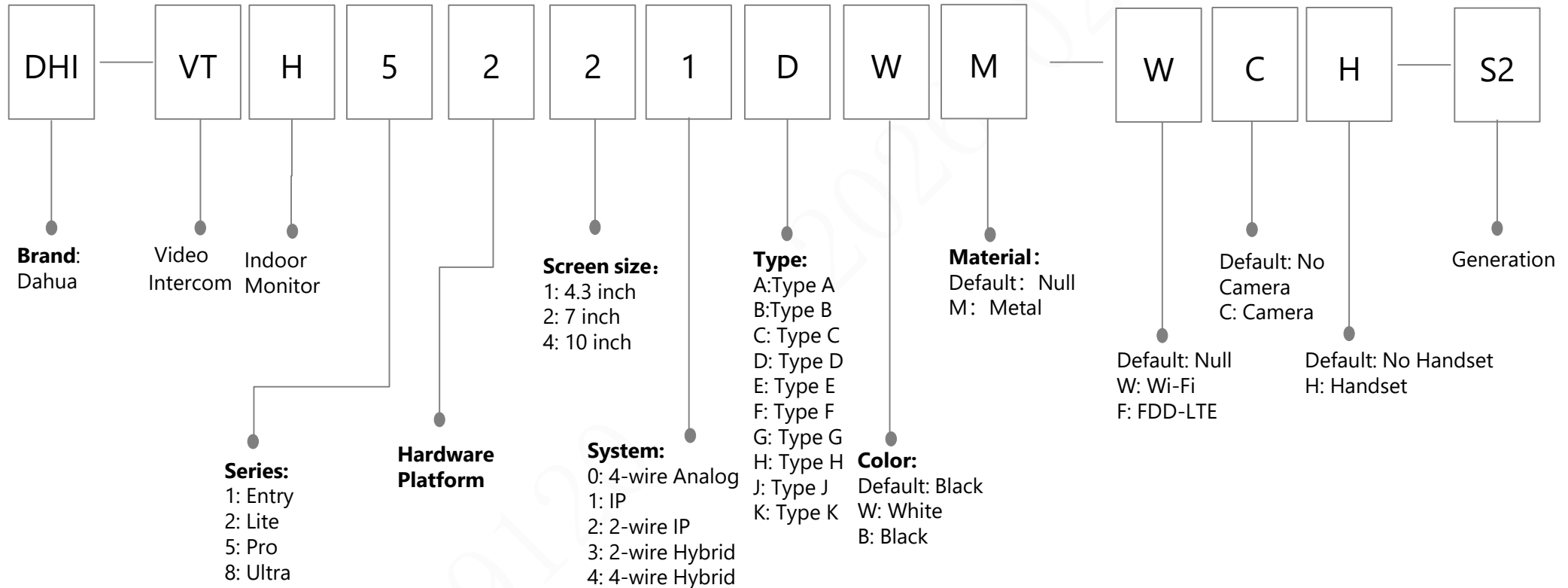

# Video Intercom(SCP)

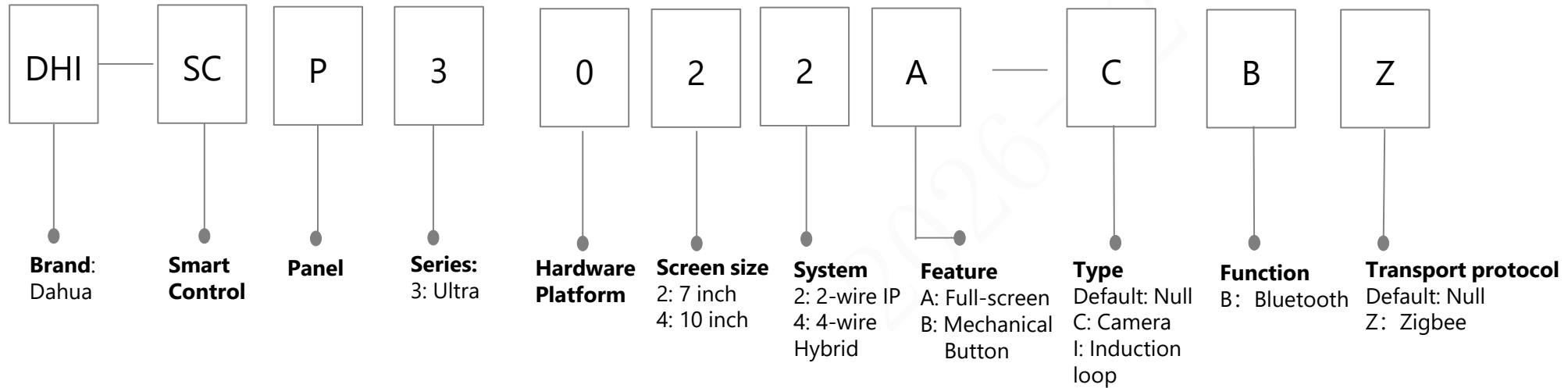

# Video Intercom(Video Doorbell & Chime)

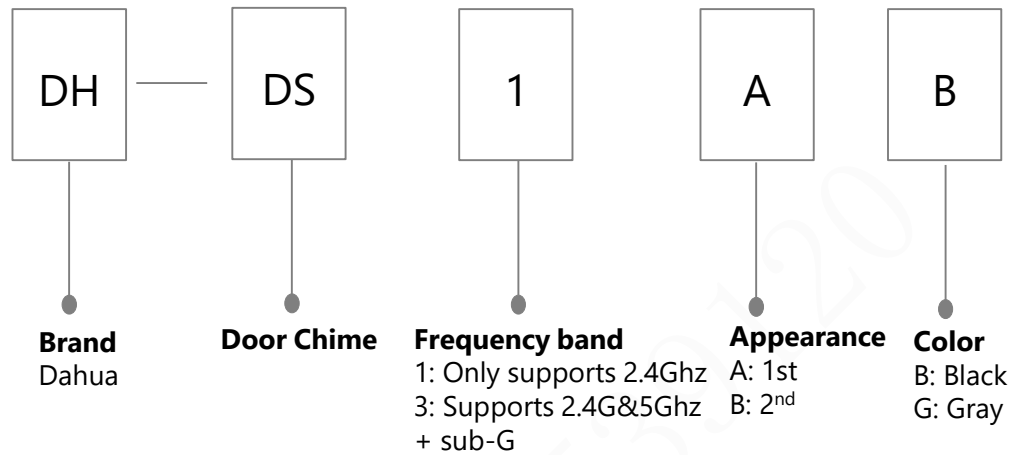
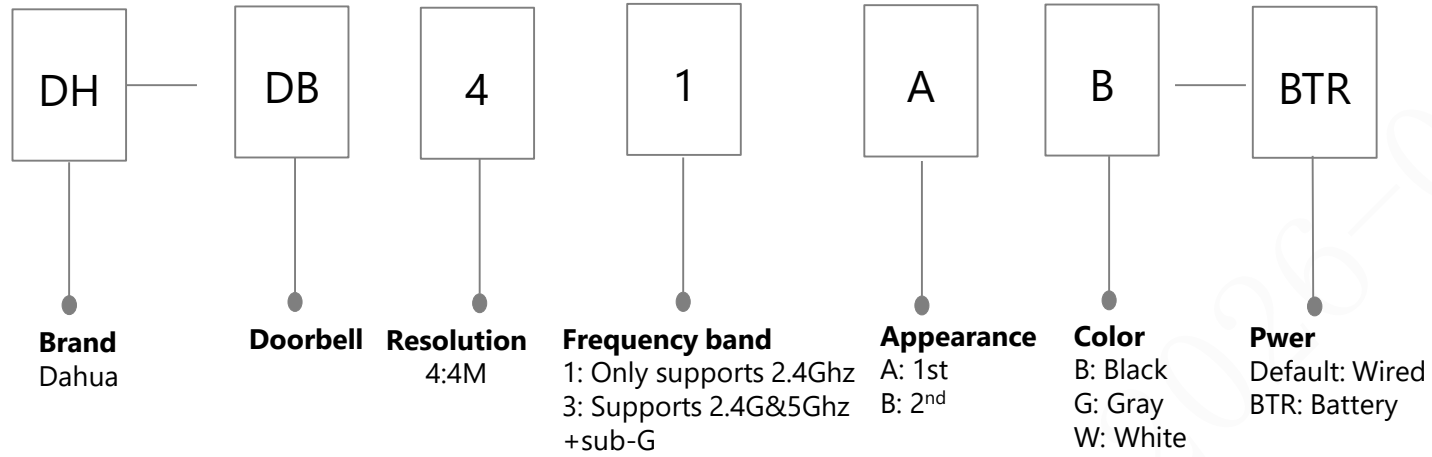

# Video Intercom(KIT)

**Notice:** The naming rule is applicable to the products released after 2019

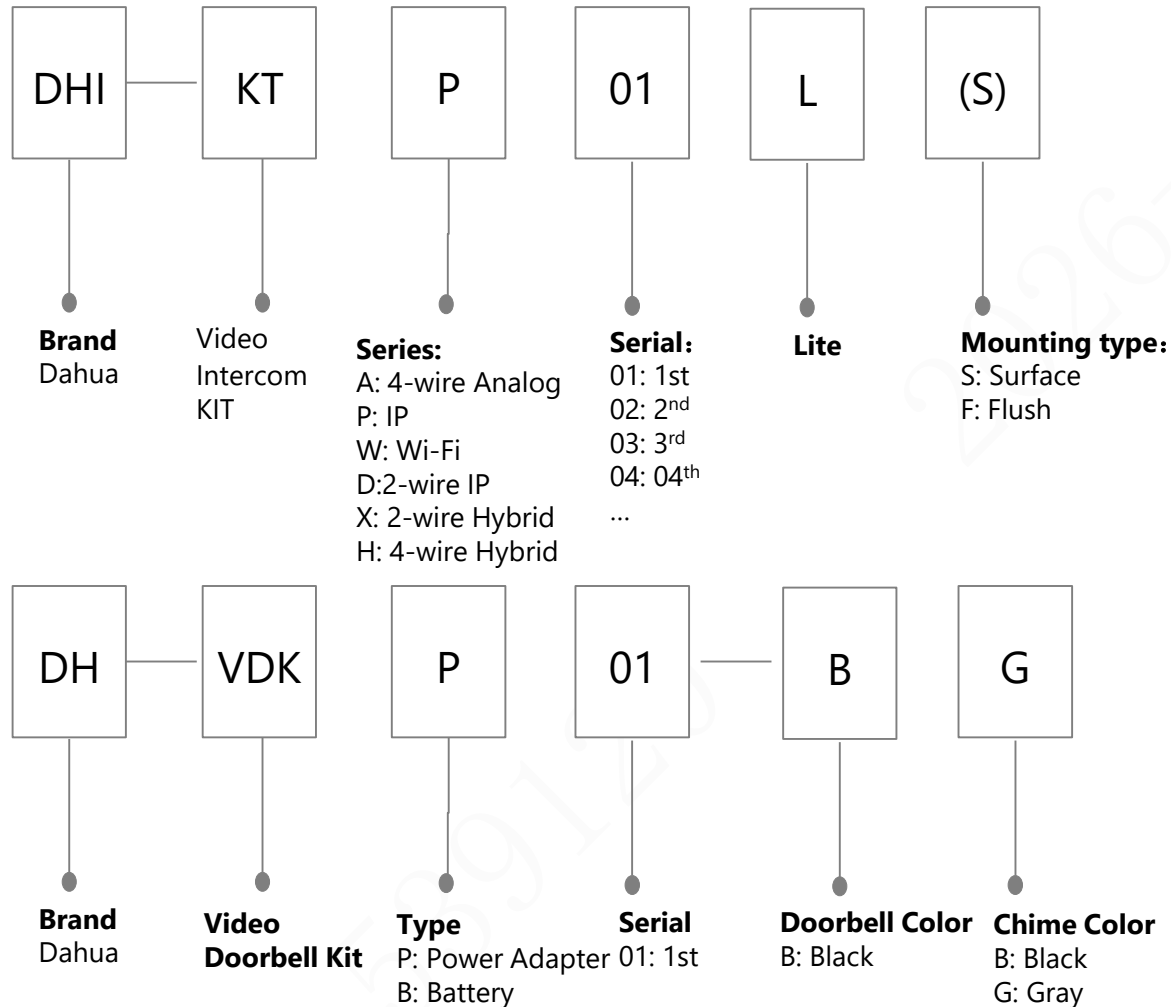

# Video Intercom(Emergency Phone Terminals)

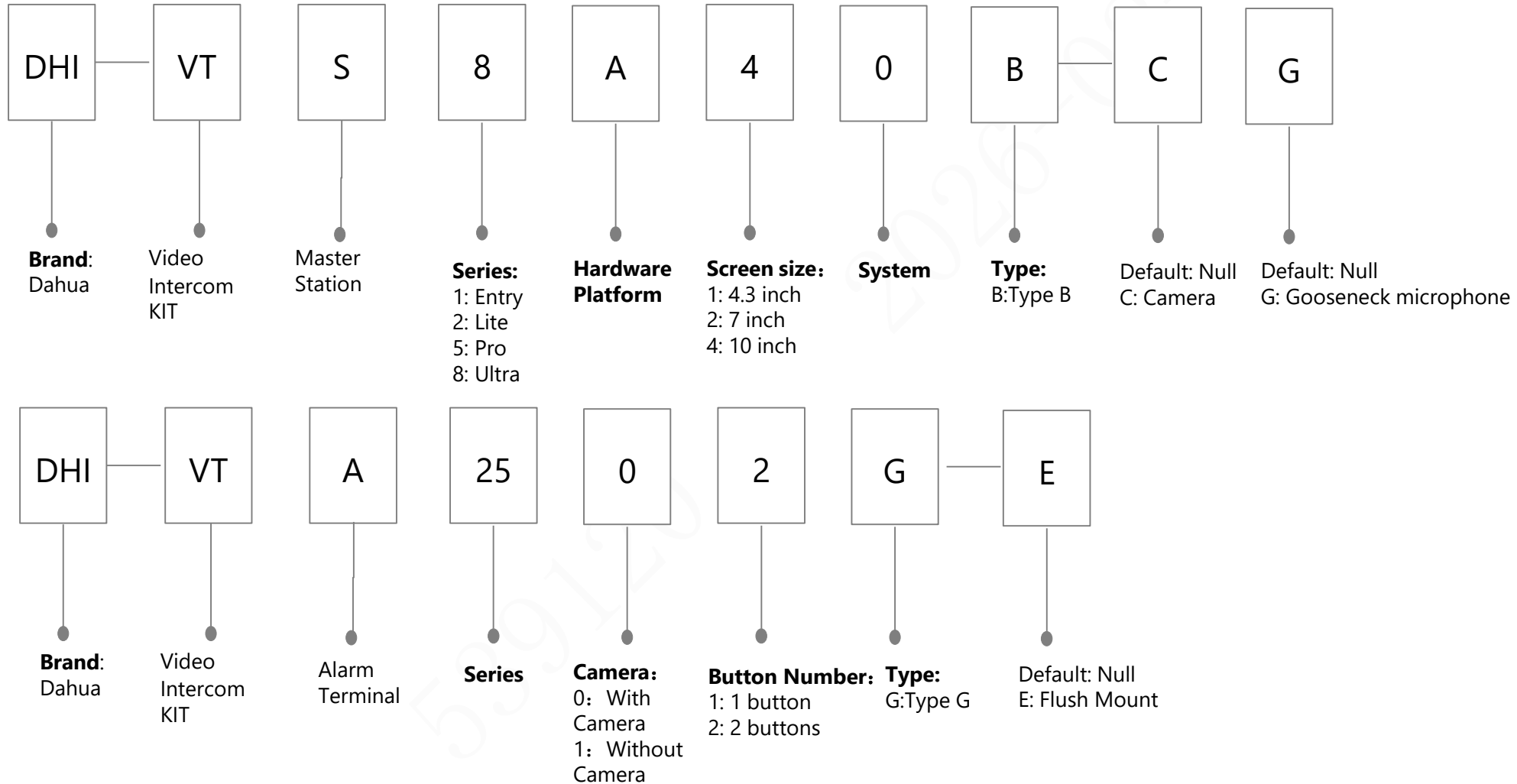

# Video Intercom(Accessory)

**Notice:** The naming rule is applicable to the products released after 2021

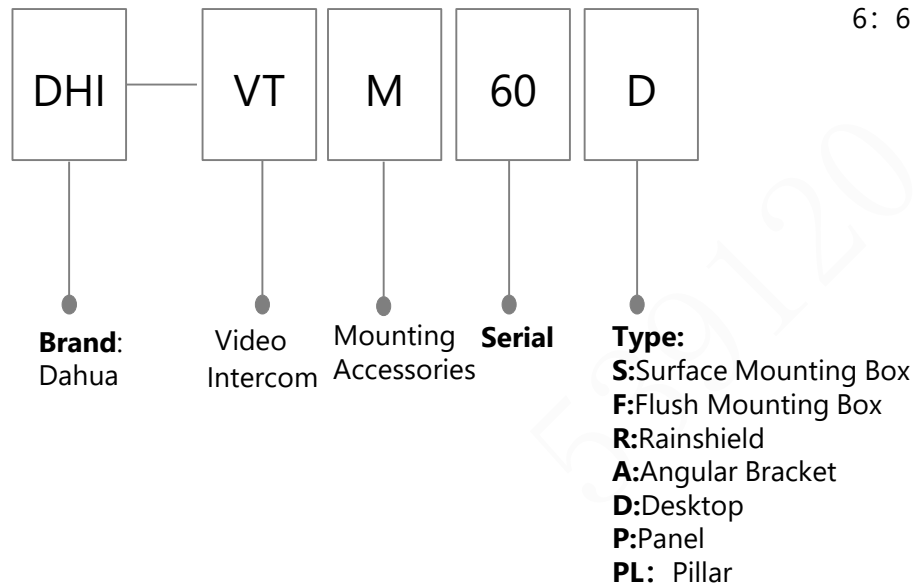
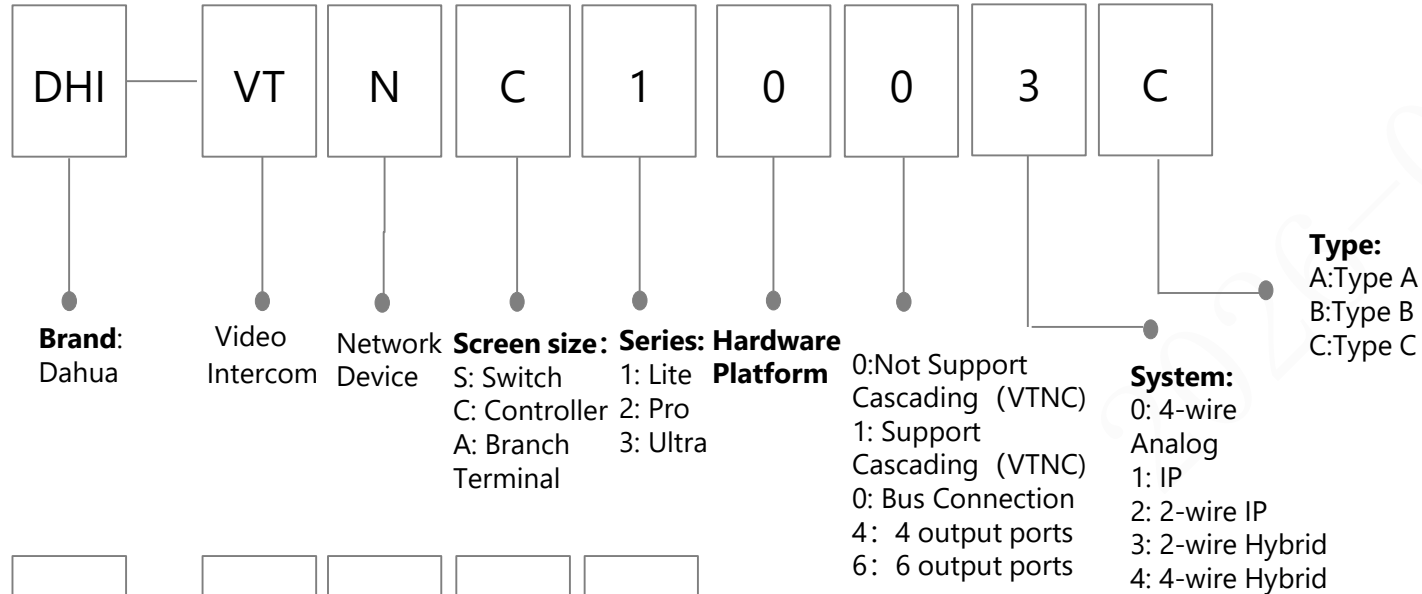

# Access Control (Integrated)

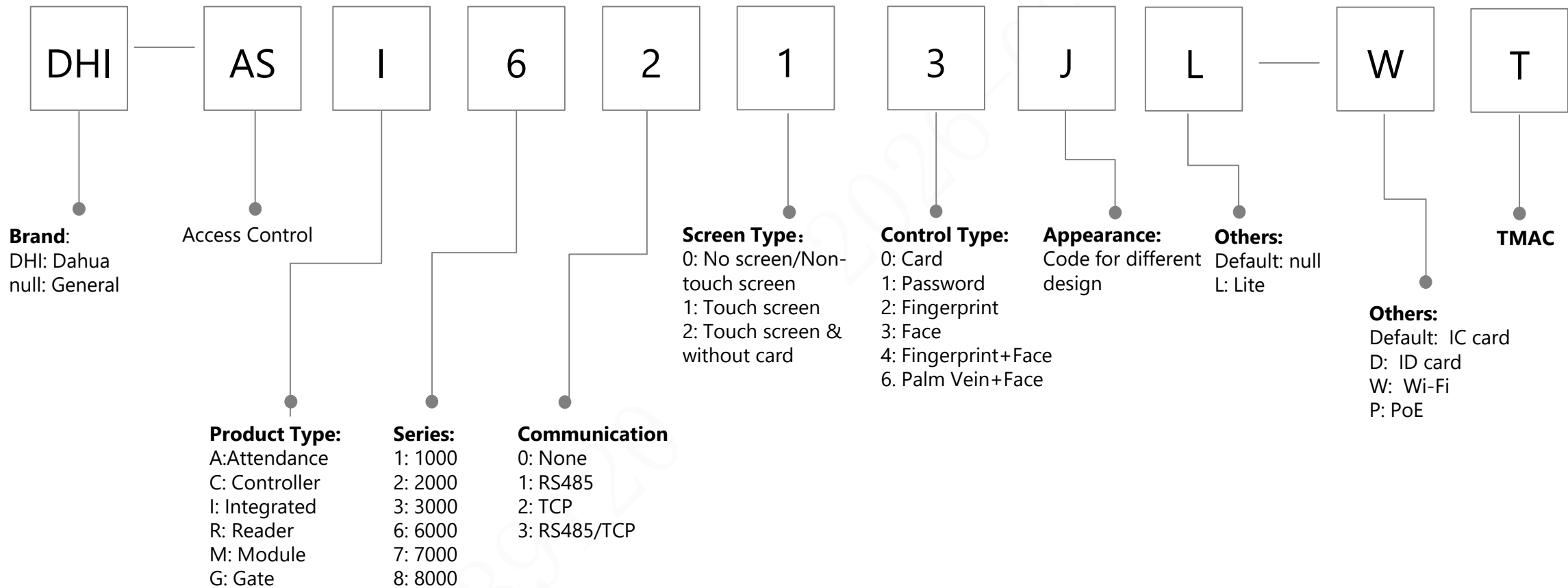

# Access Control (Controller)

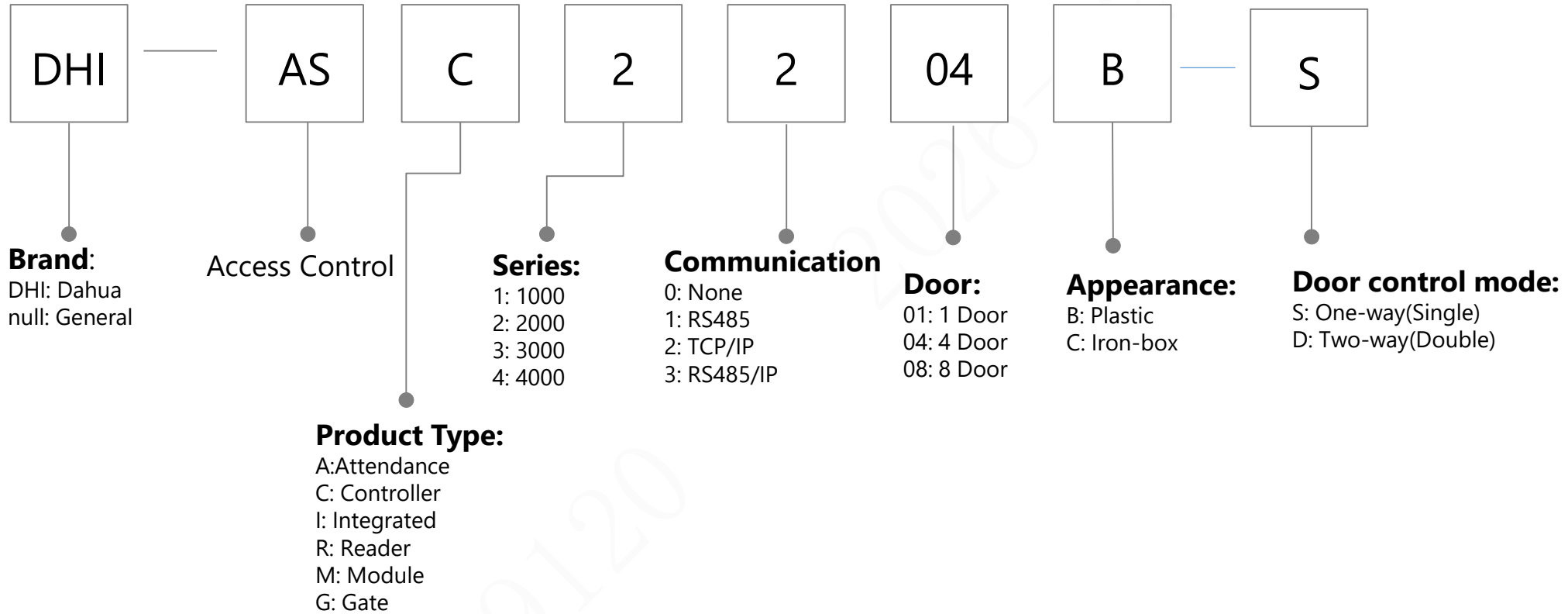

# Access Control (Reader)

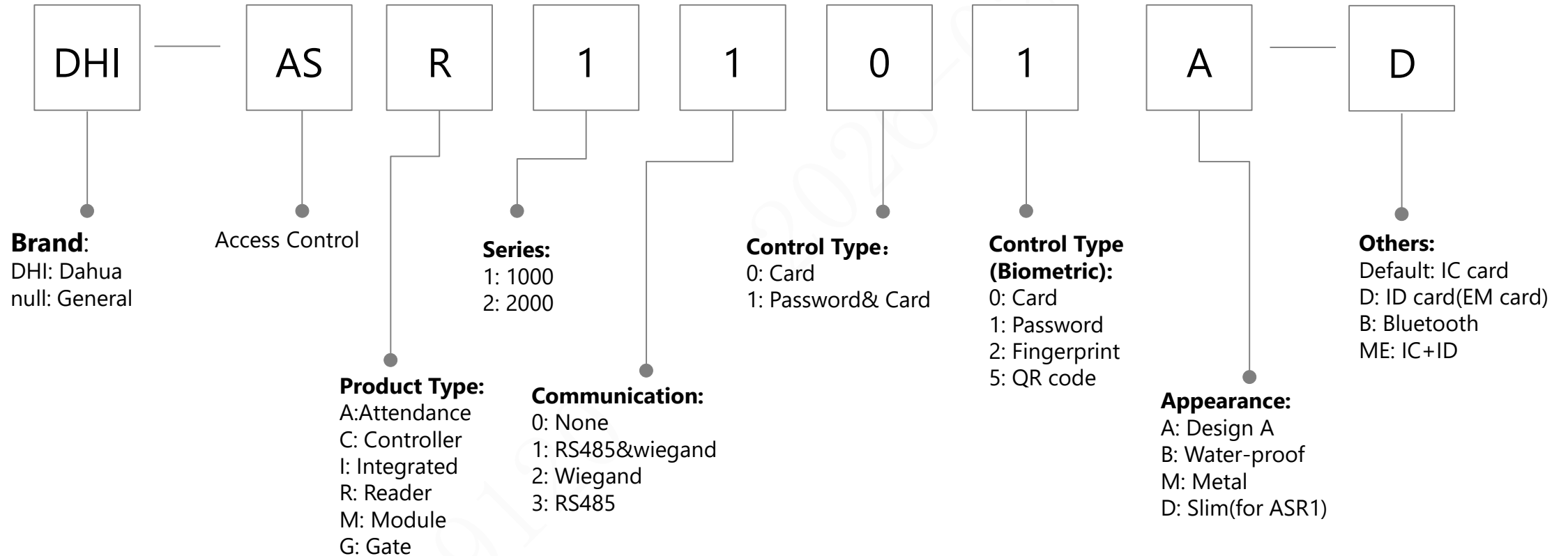

# Access Control (Module)

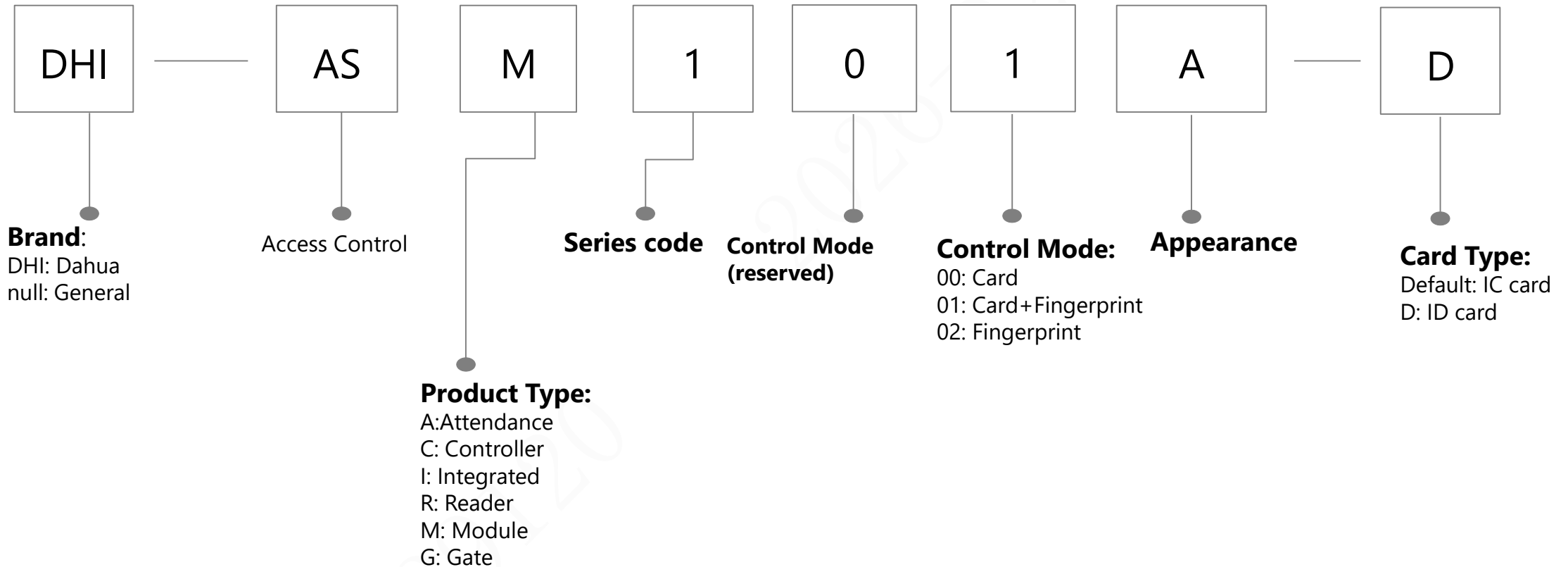

# Access Control (Attendance)

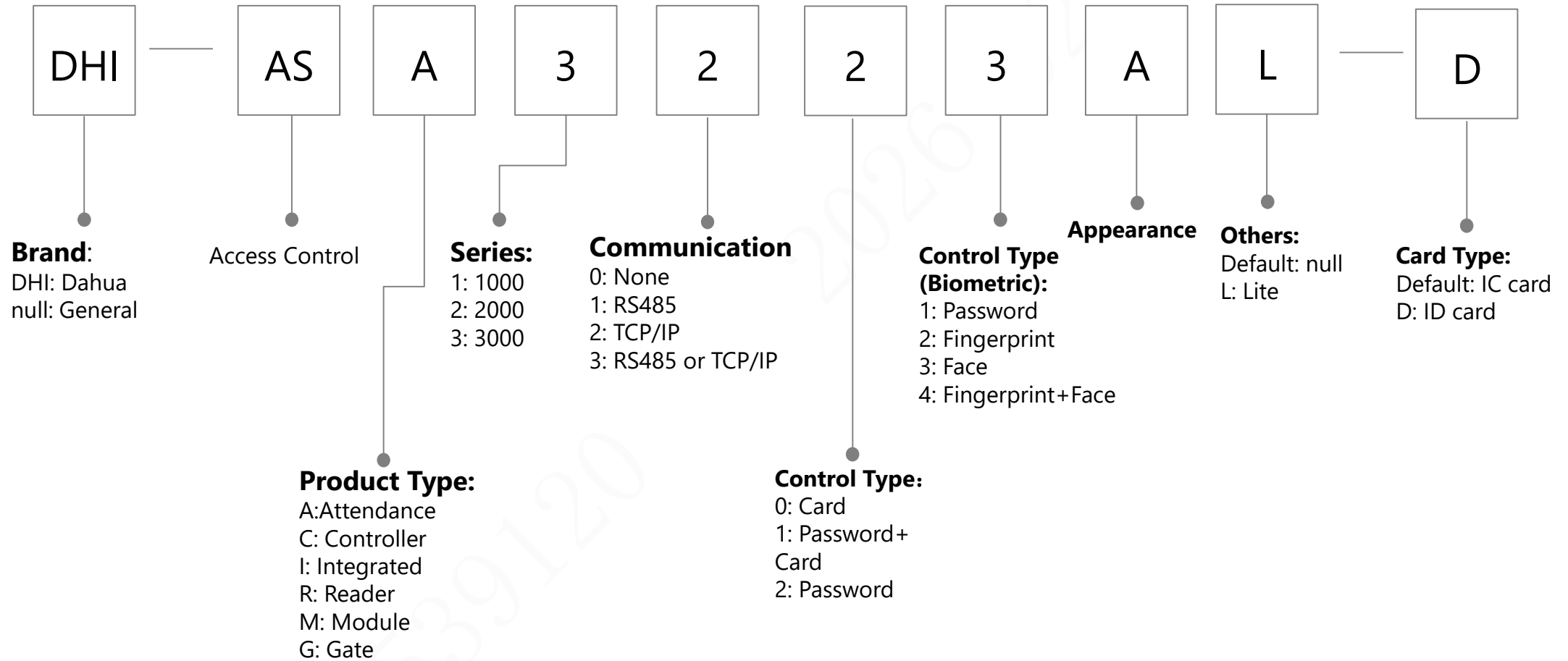

# Access Control (Turnstile)

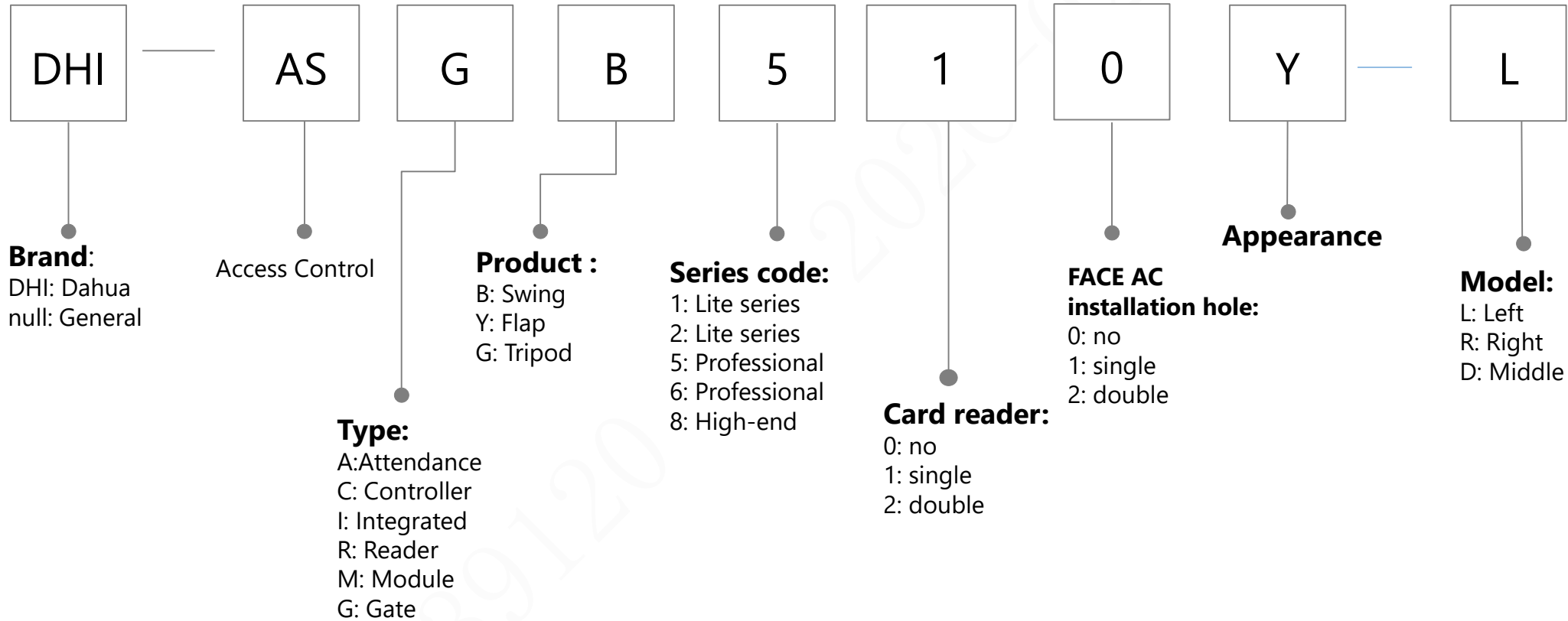

# Alarm (Controller)

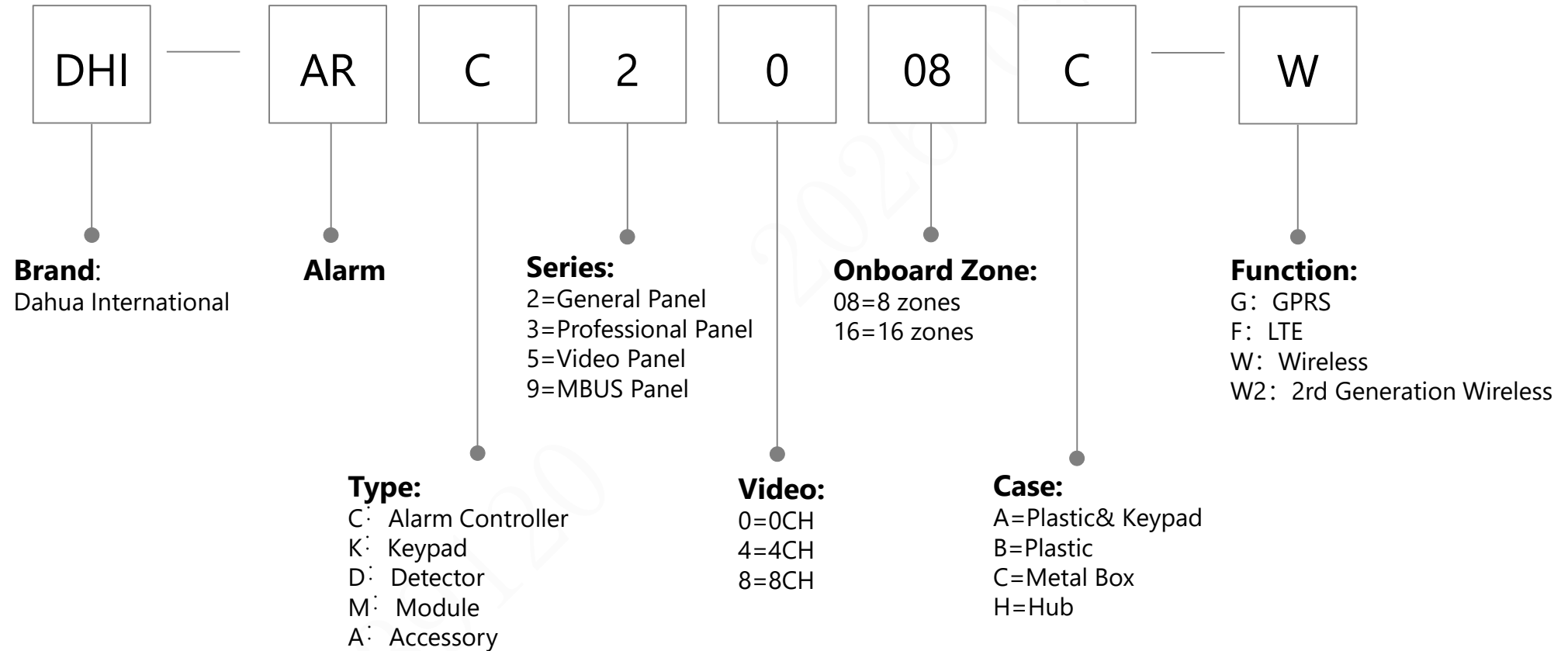

# Alarm (Keypad & Module)

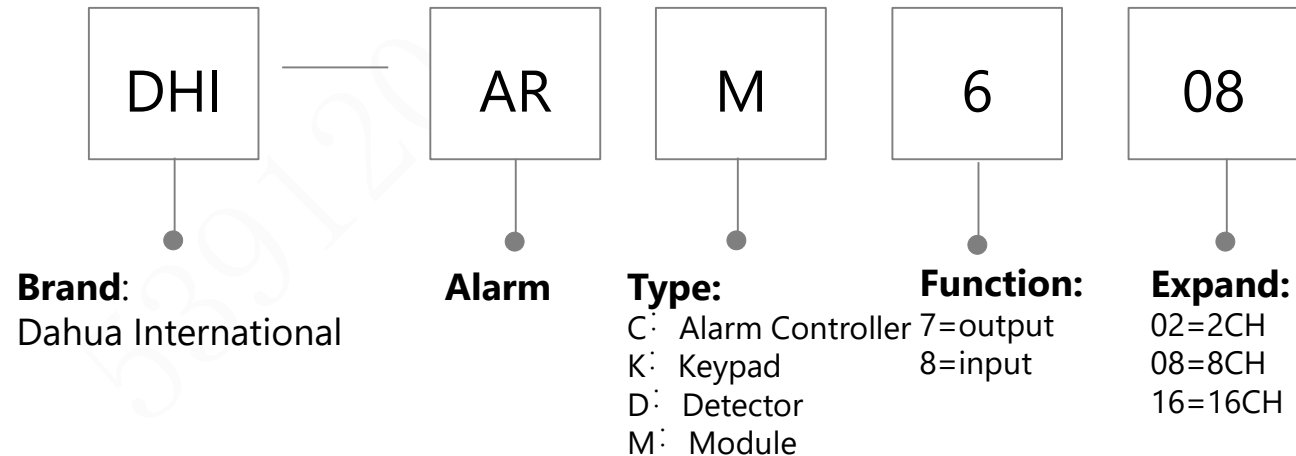
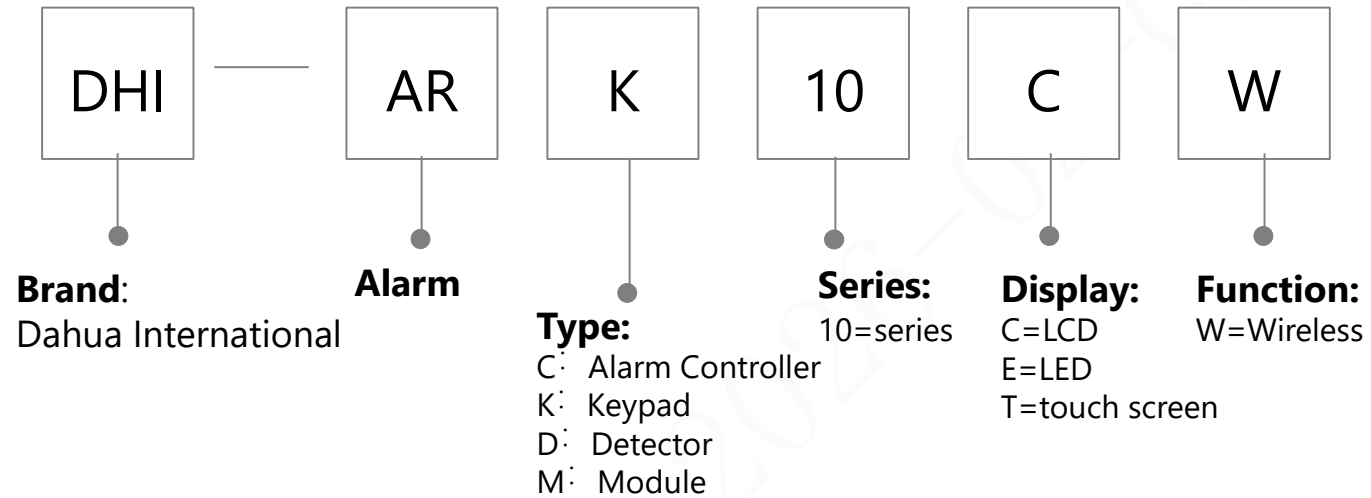

# ITS-Traffic Camera

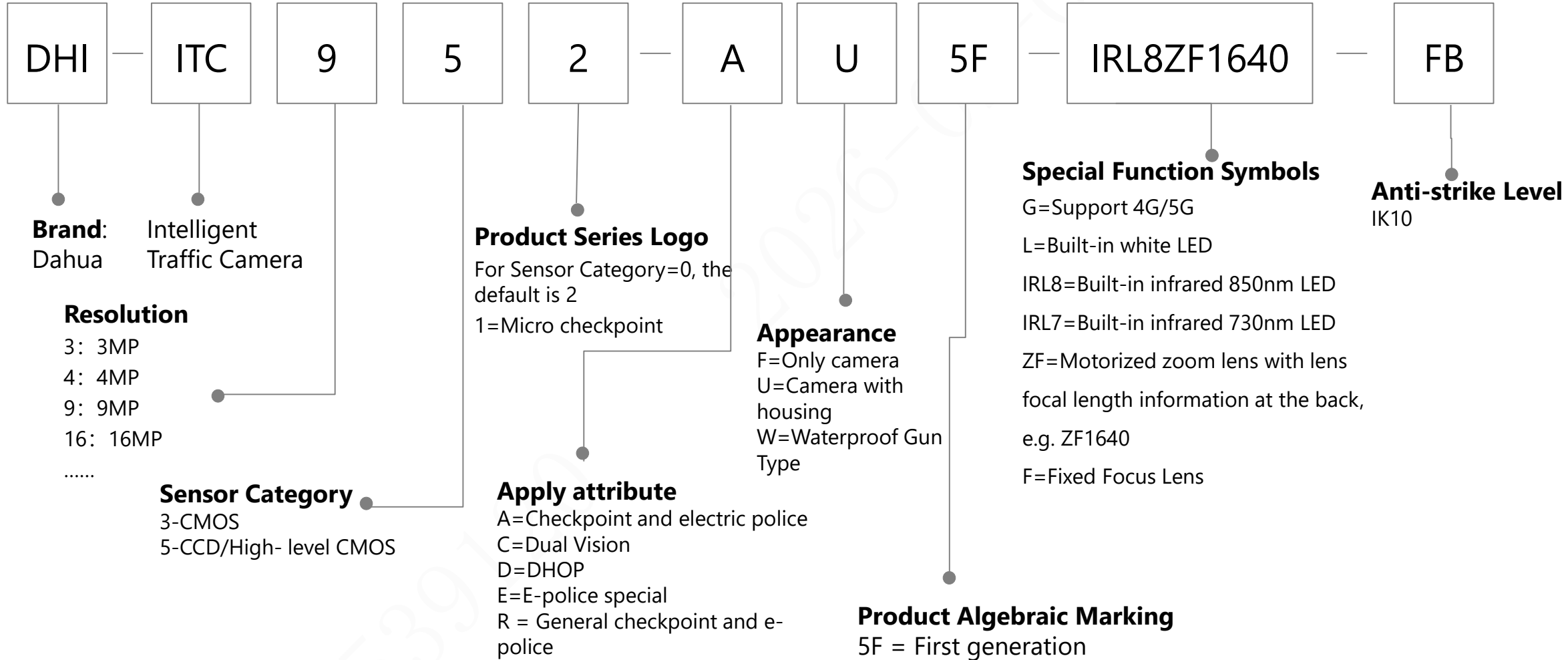

# ITS-Traffic Camera-Spotter sky

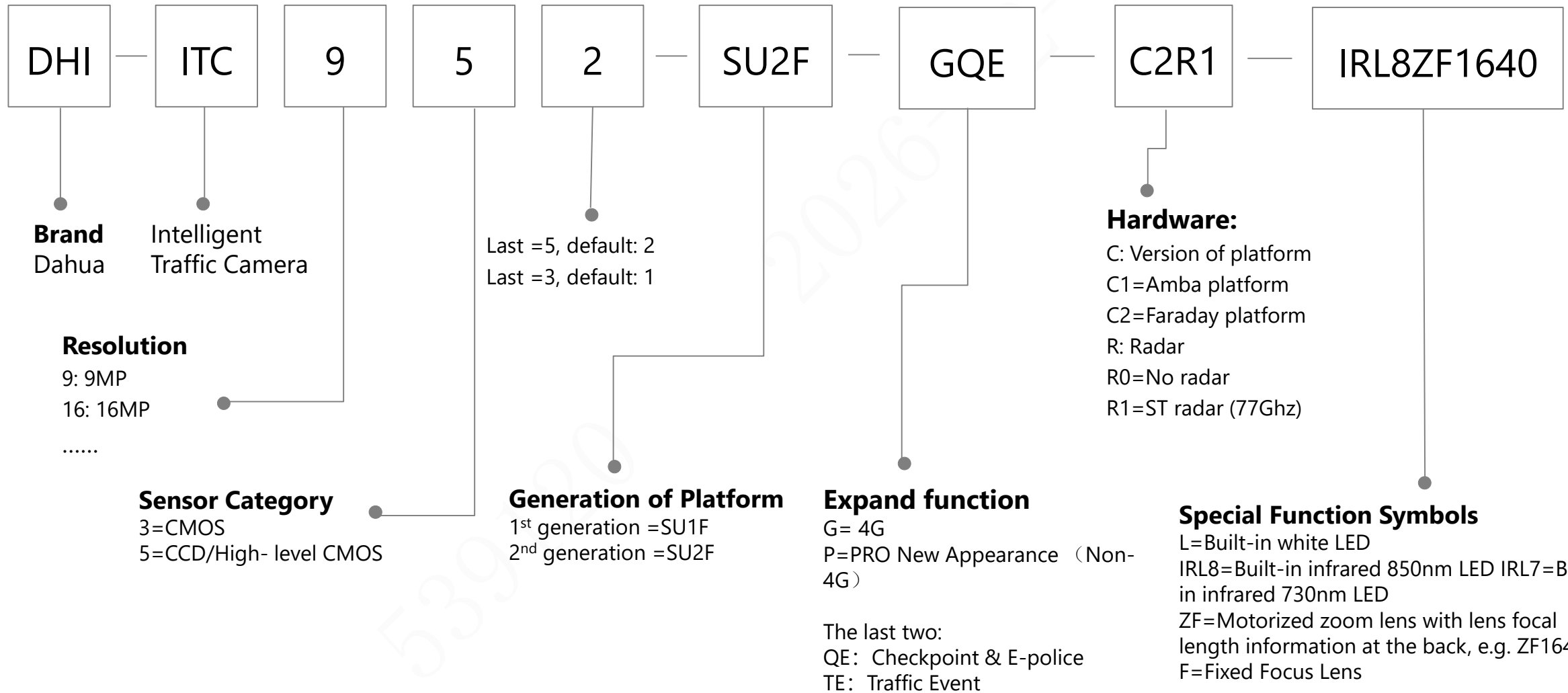

# ITS-Traffic Edge Storage (ITSE)

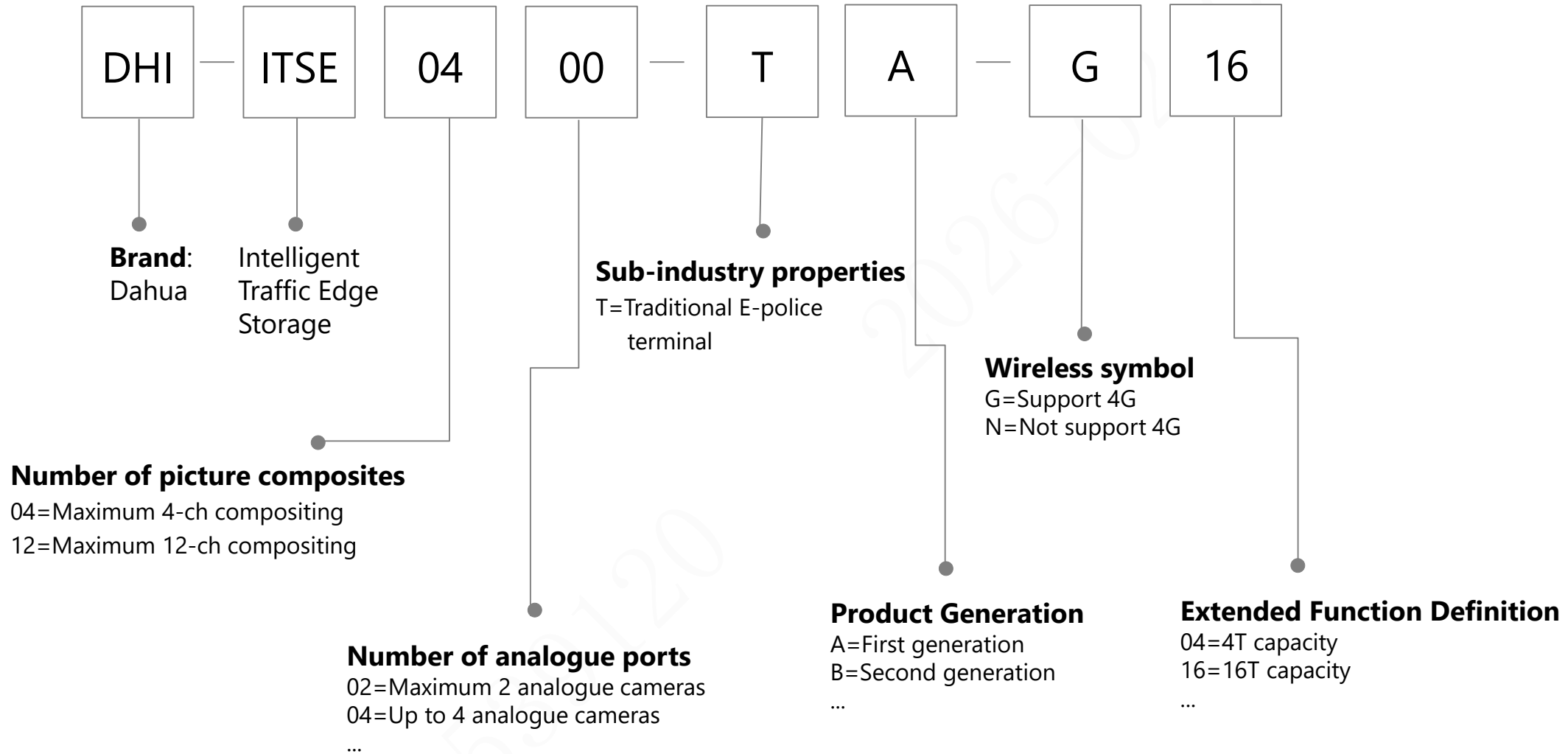

# ITS-Traffic Lamp

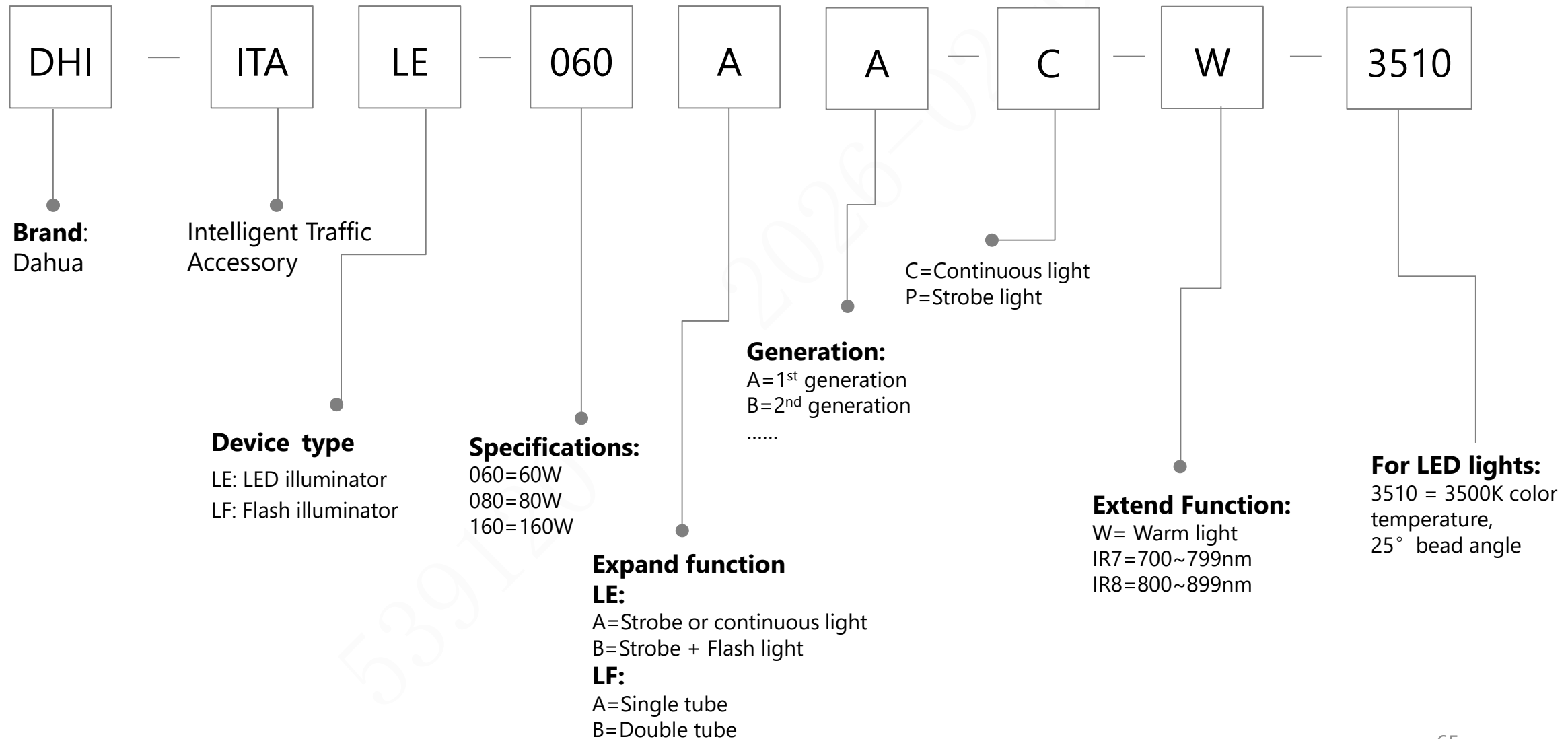

# ITS-Traffic Radar

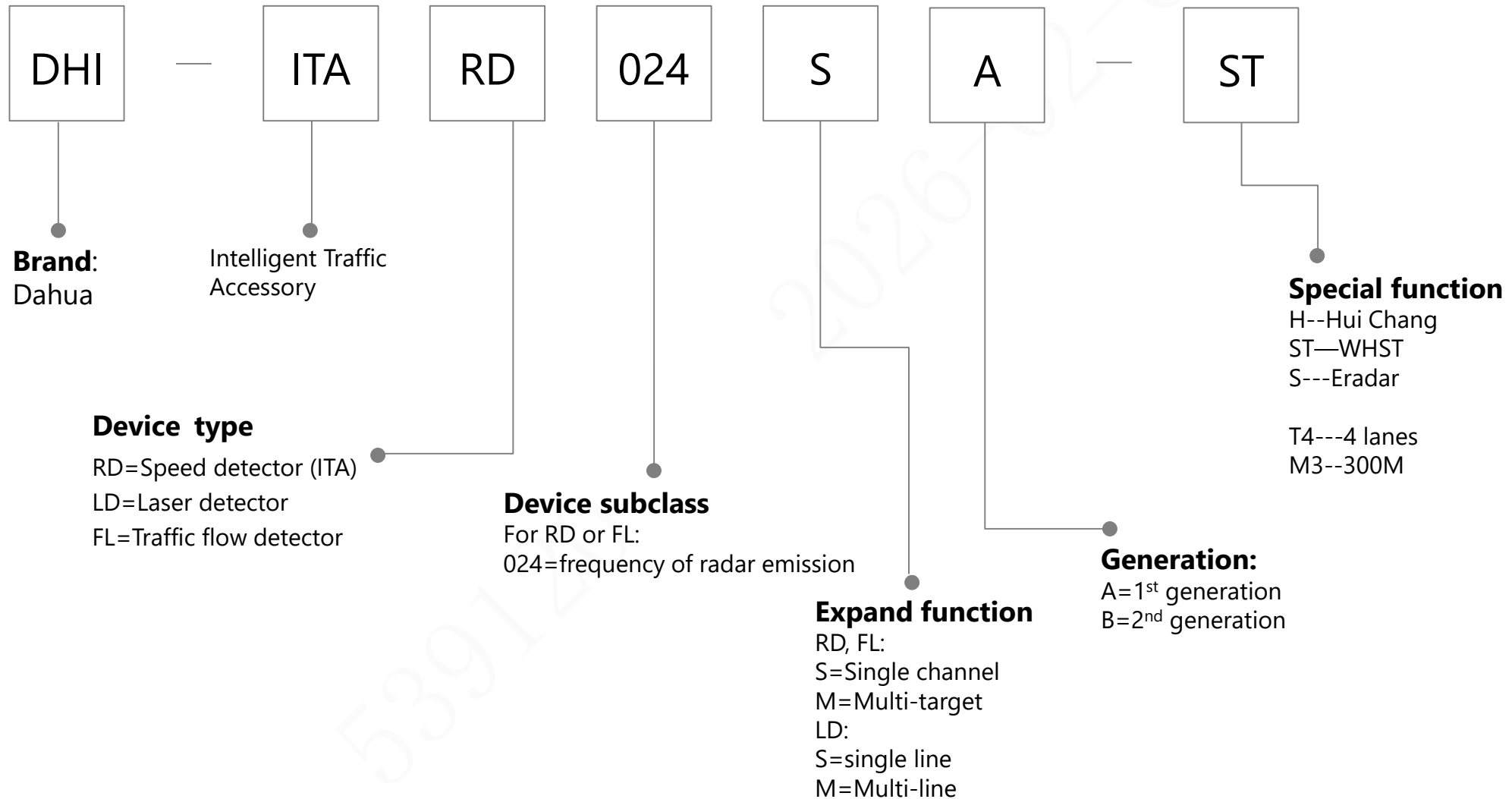

# ITS-Traffic Signal Controller

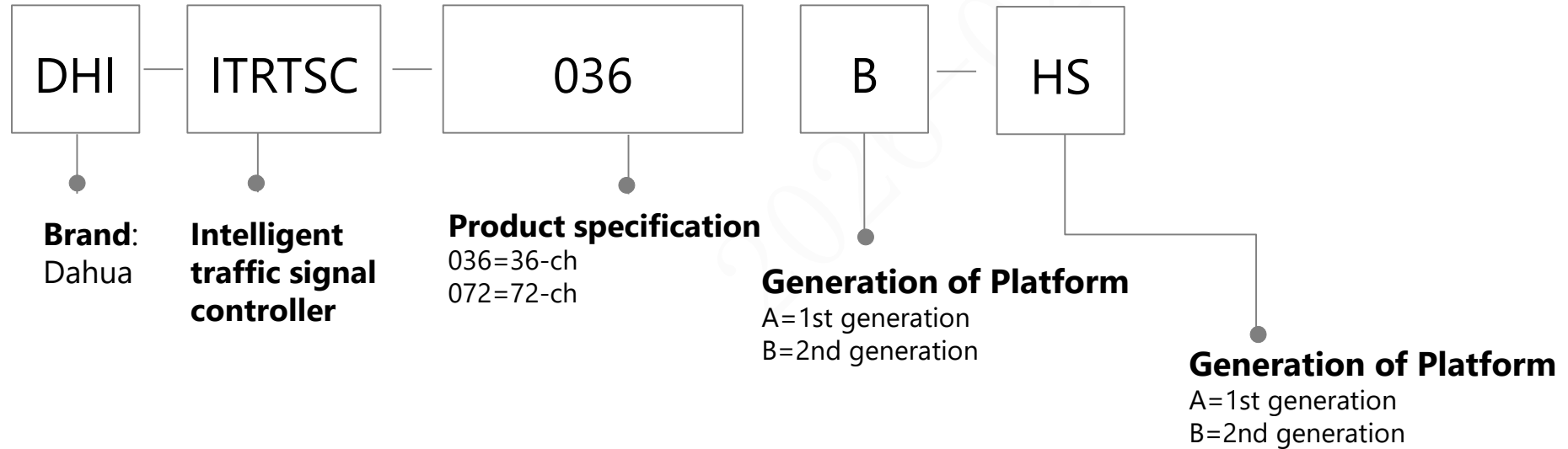

# ITS-Speed Measuring System

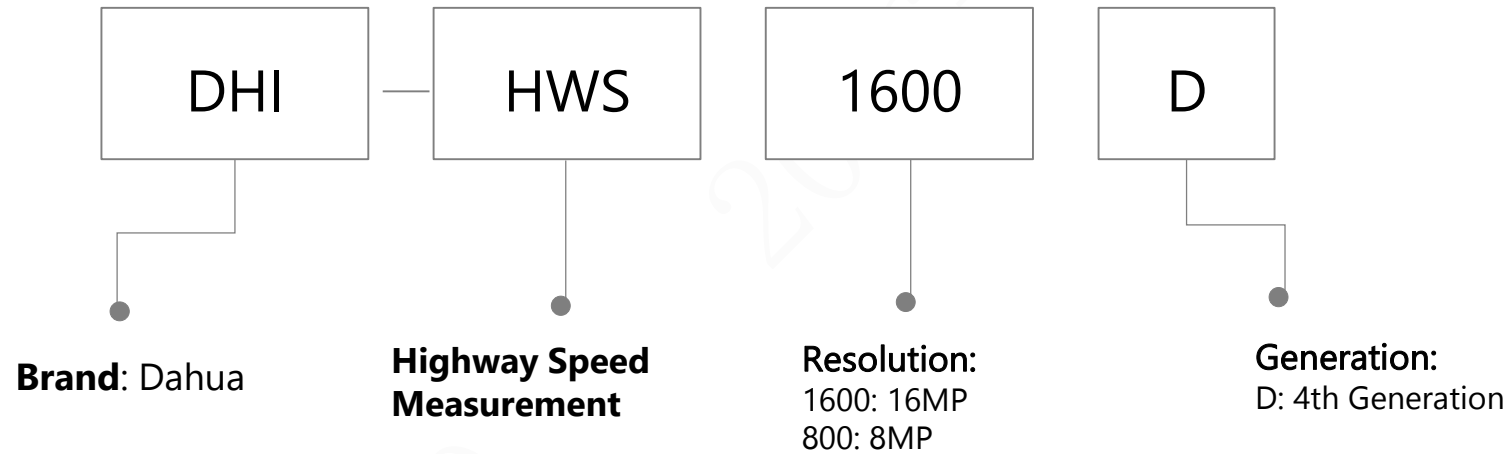

# ITS-Access ANPR Camera

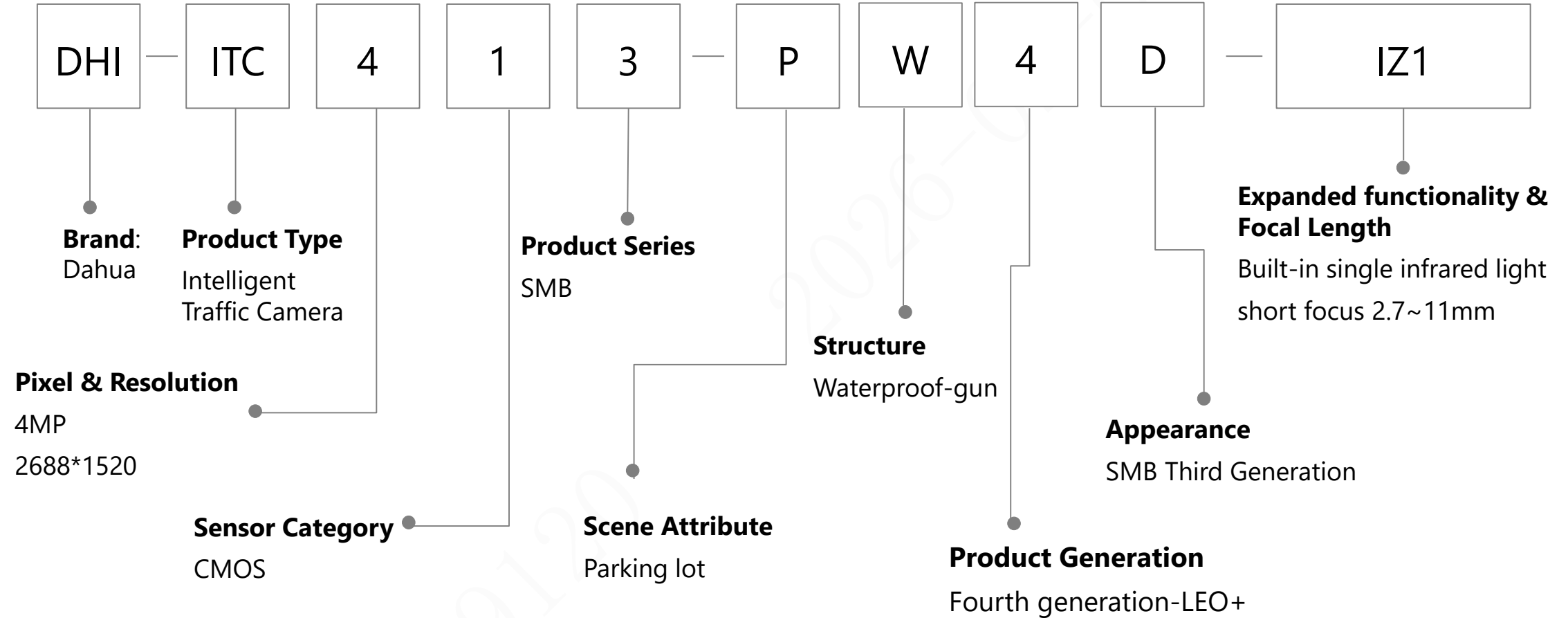

# ITS-4MP Spot Detection Camera

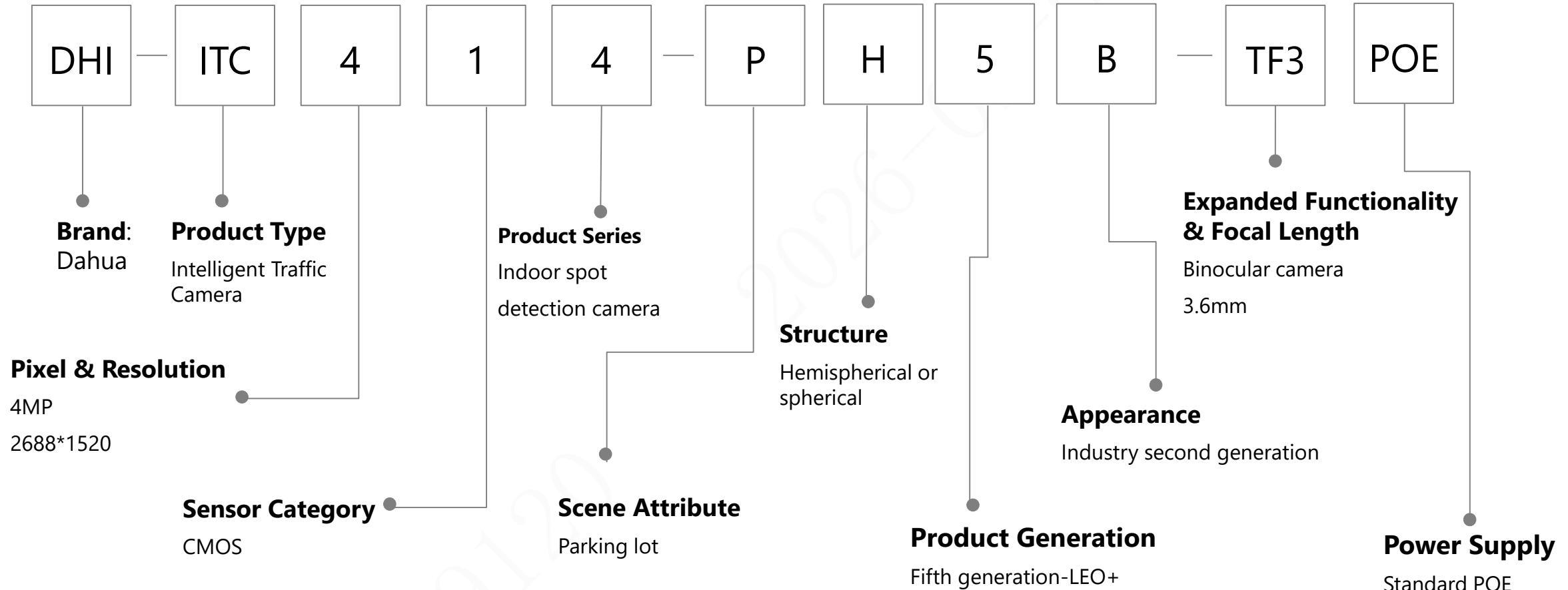

# ITS-4MP Spot Detection Camera

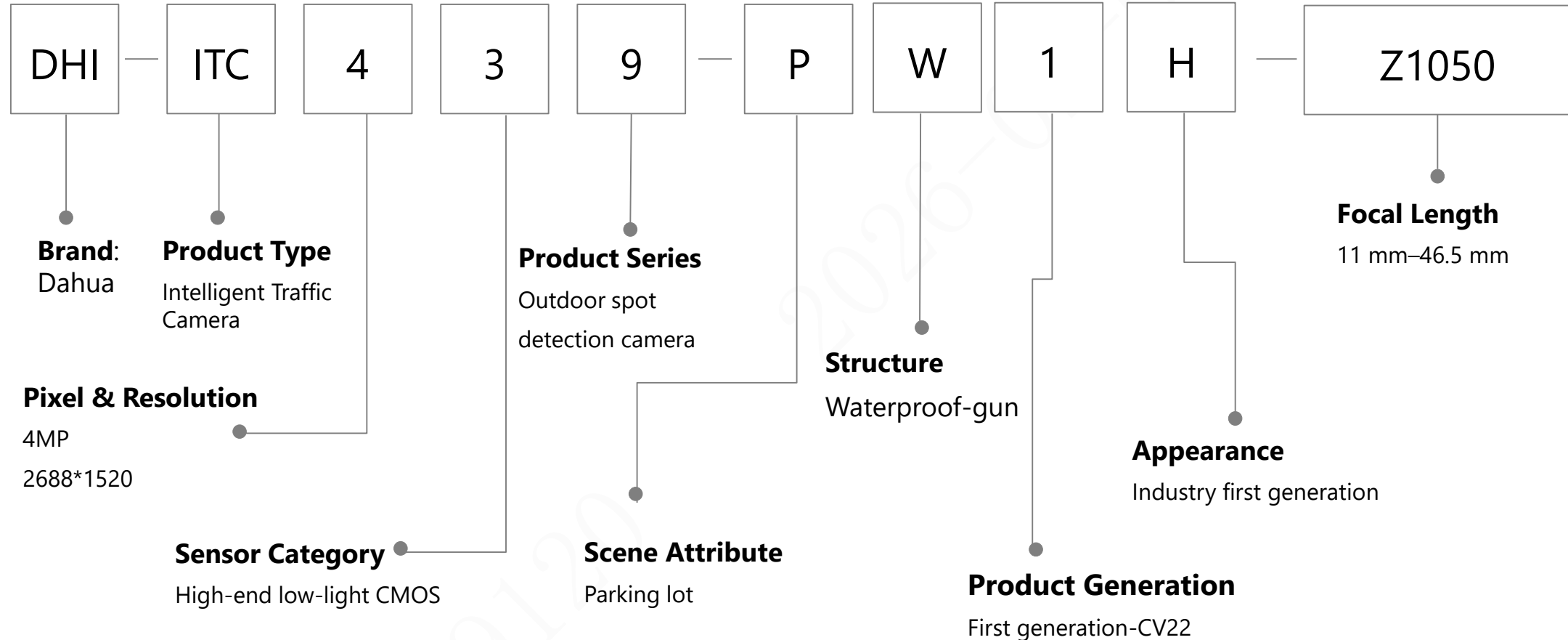

# ITS-Access Barrier

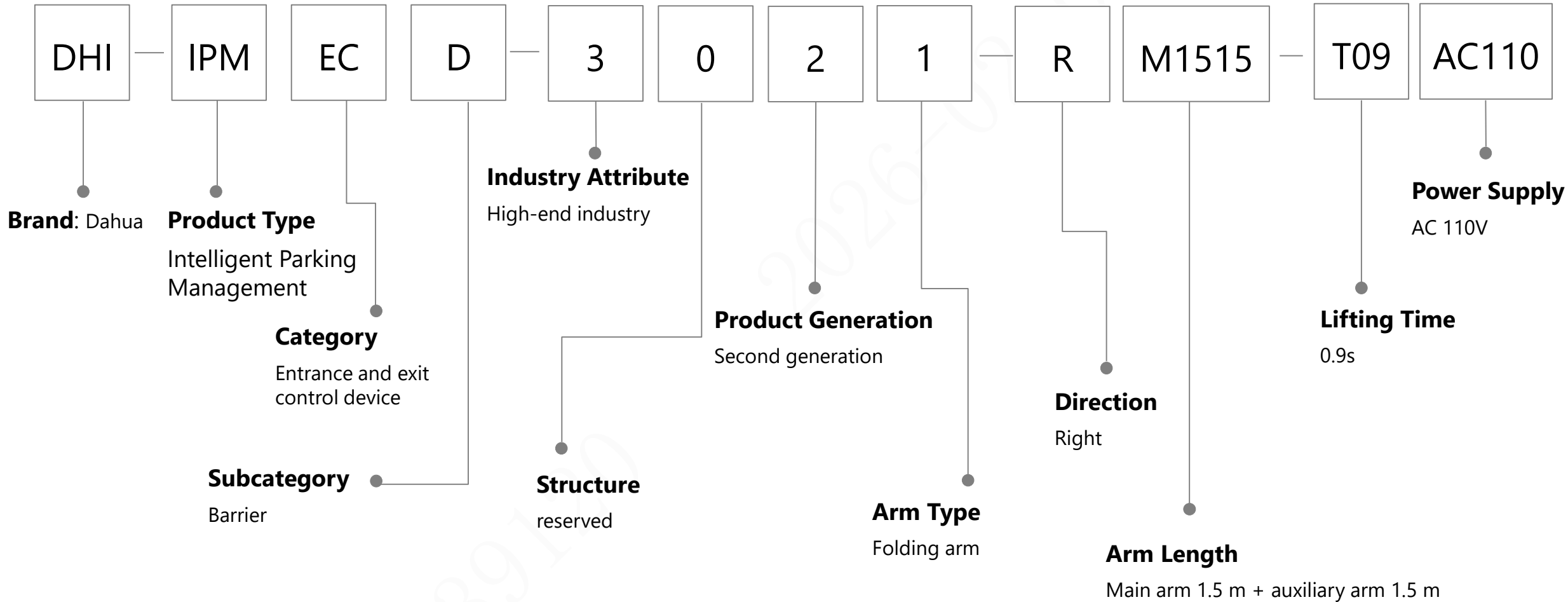

# ITS-Folding Arm 1.5m-1.5m

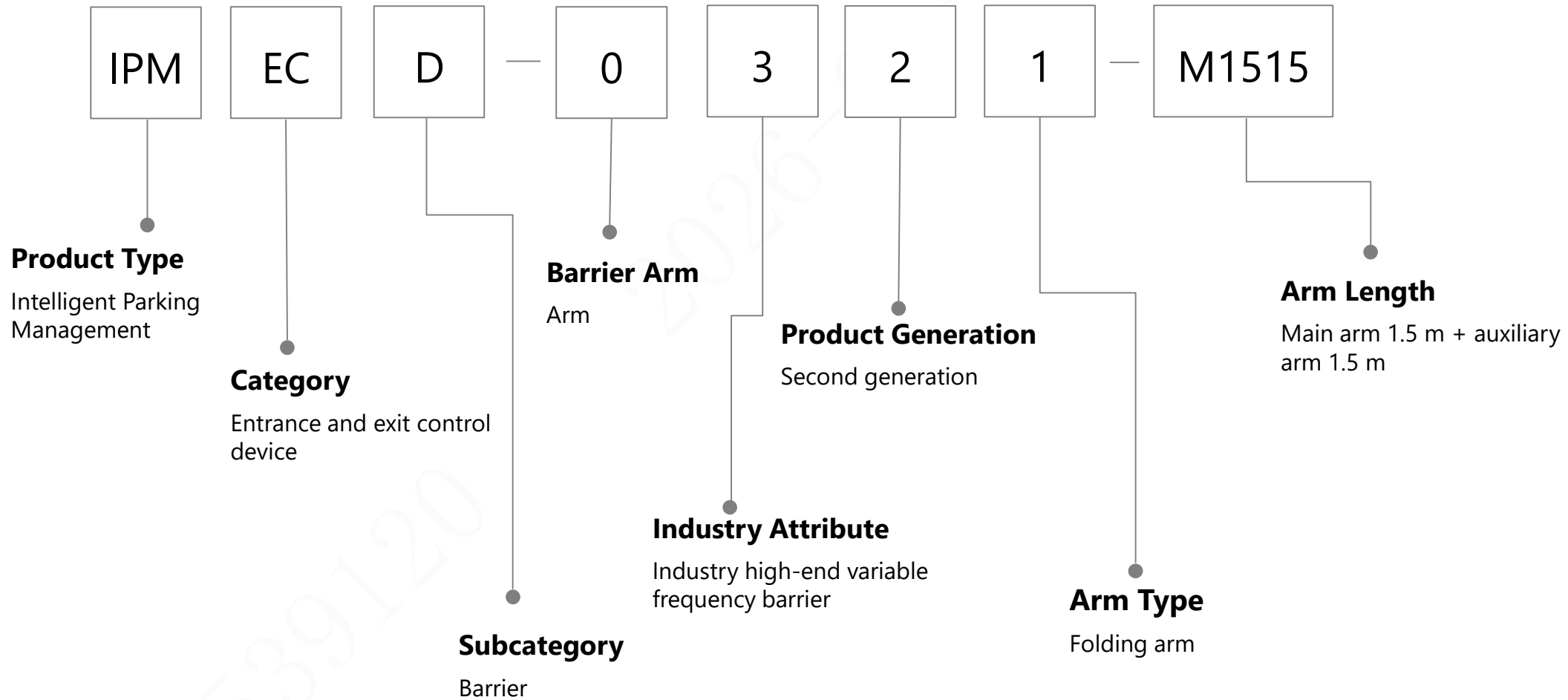

# ITS-Indoor Guidance Screen (One-Layer)

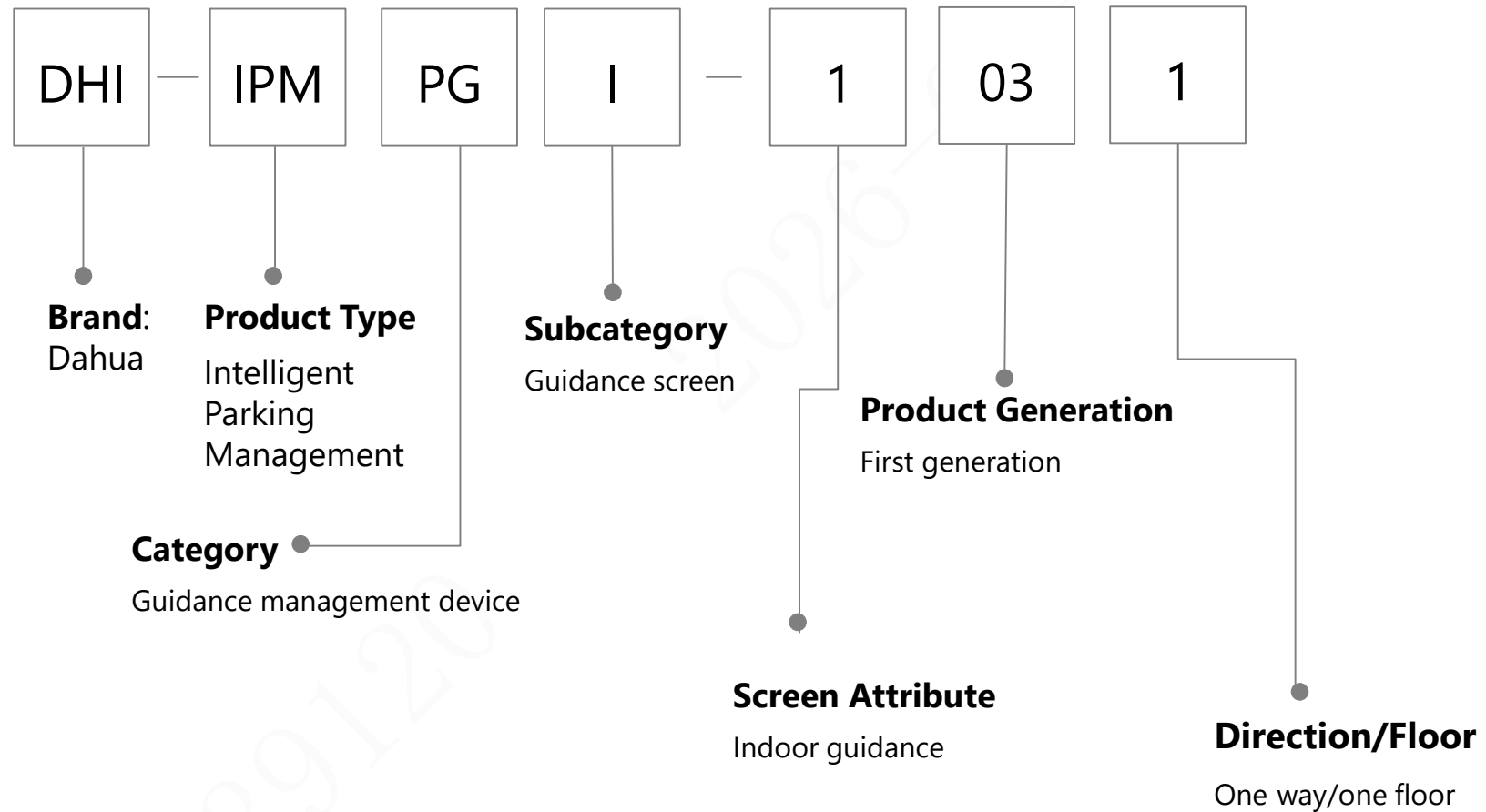

# ICS-AC EV Charger

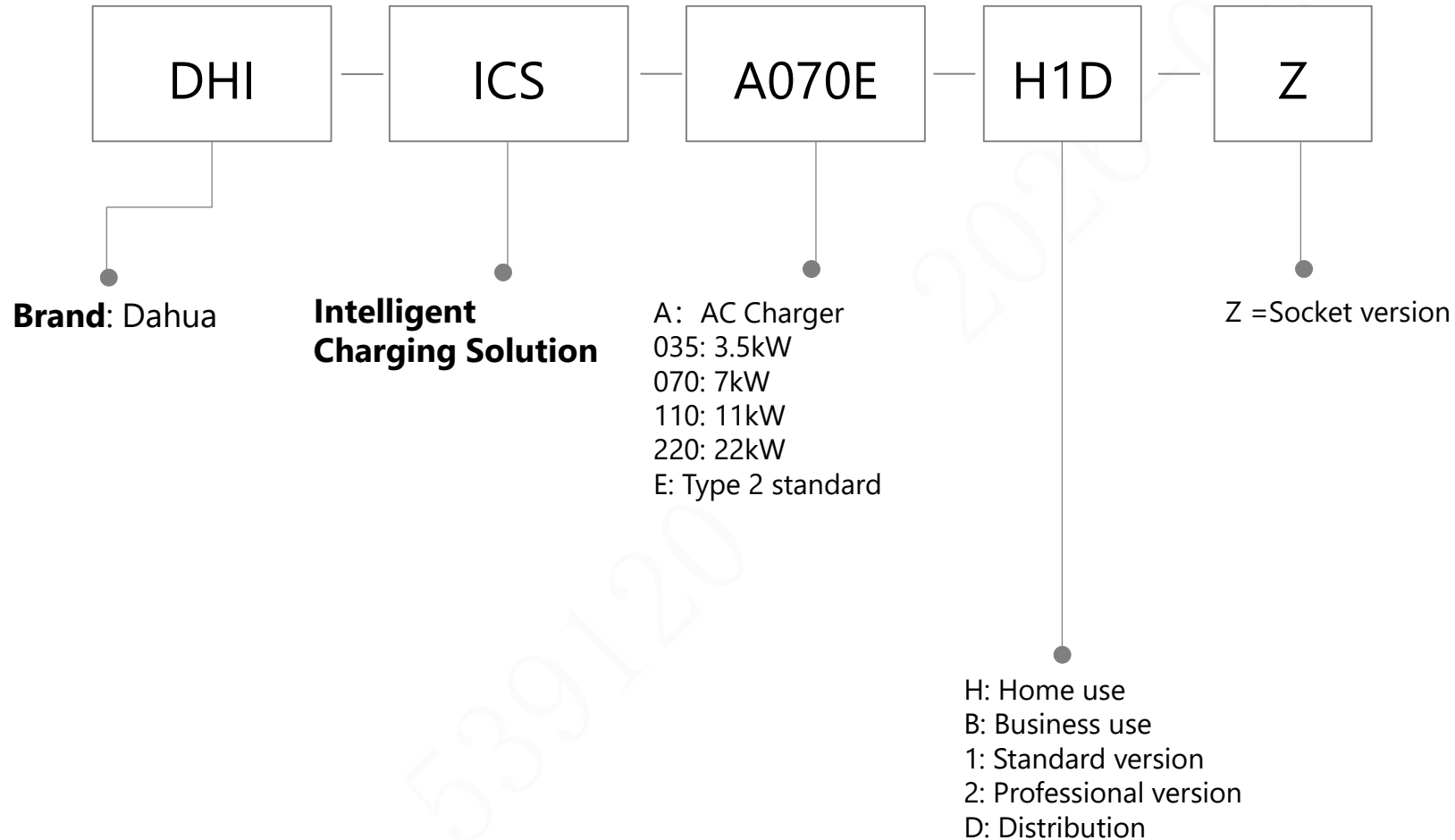

# ICS-DC EV Charger

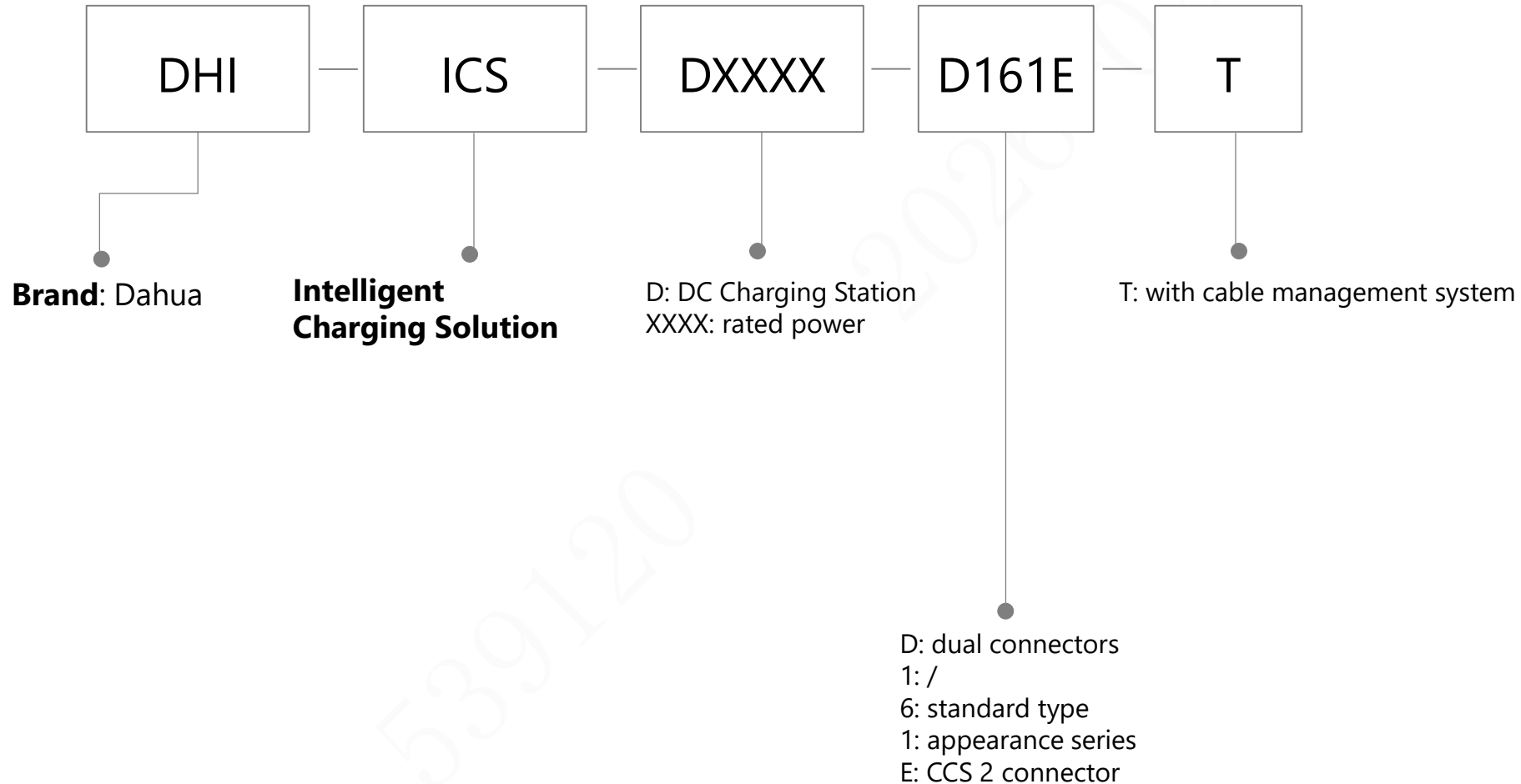

# D-Volt Charging System

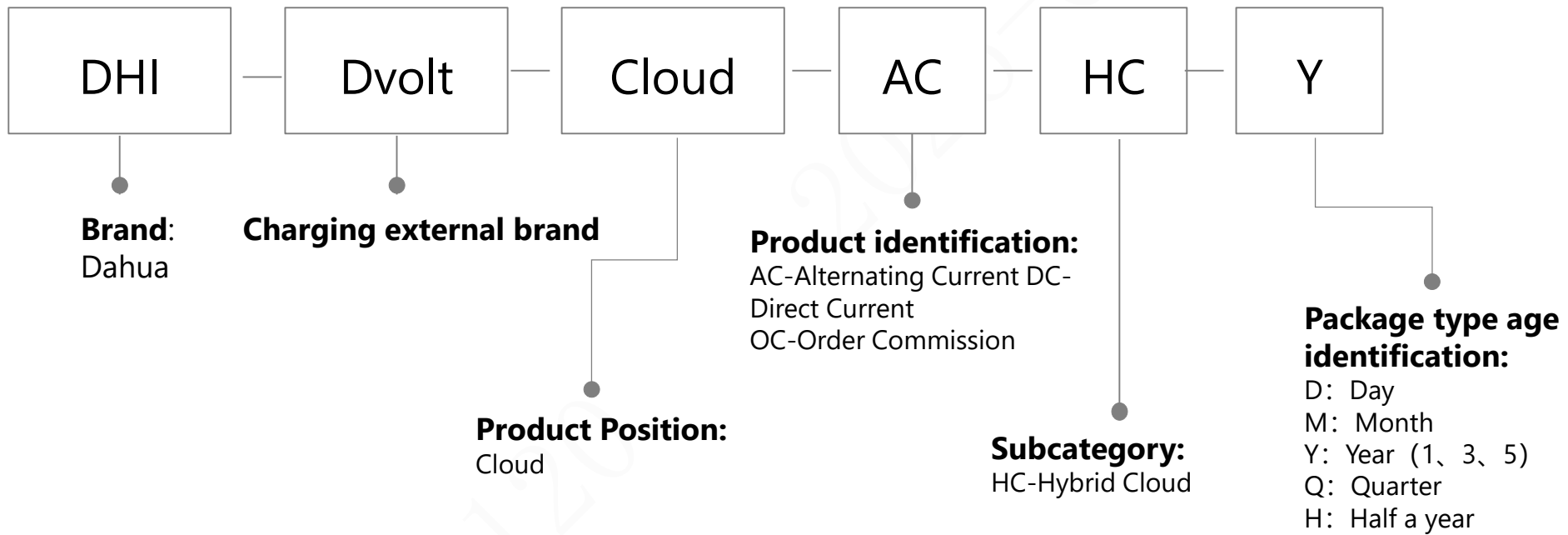

# SSD

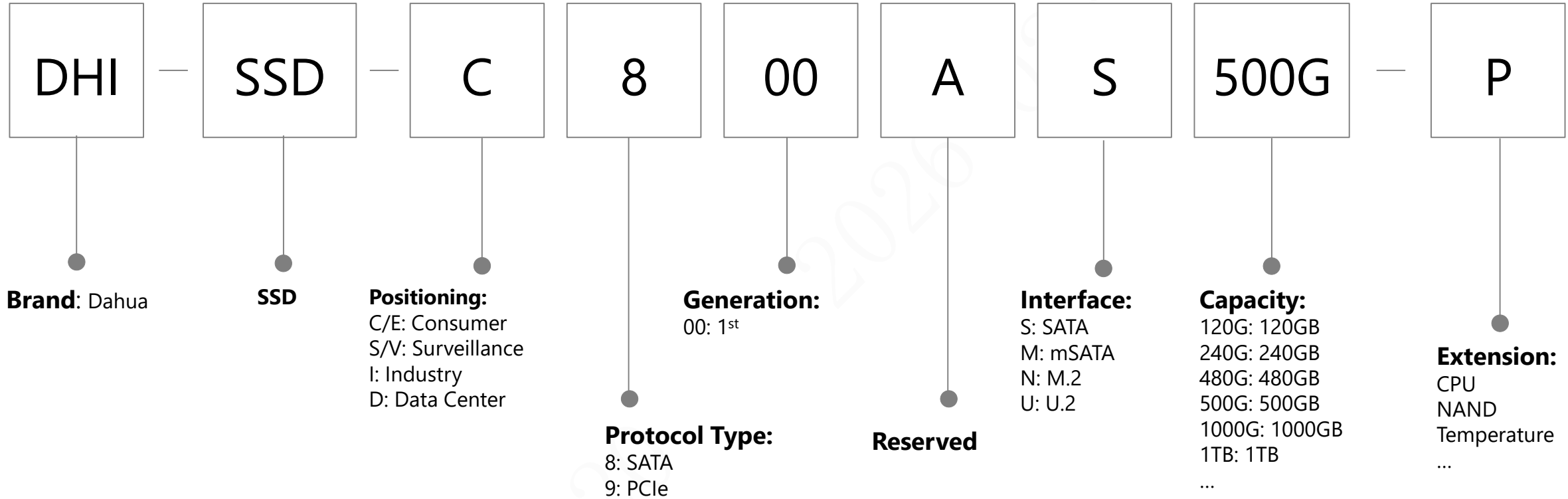

# Thermal Camera

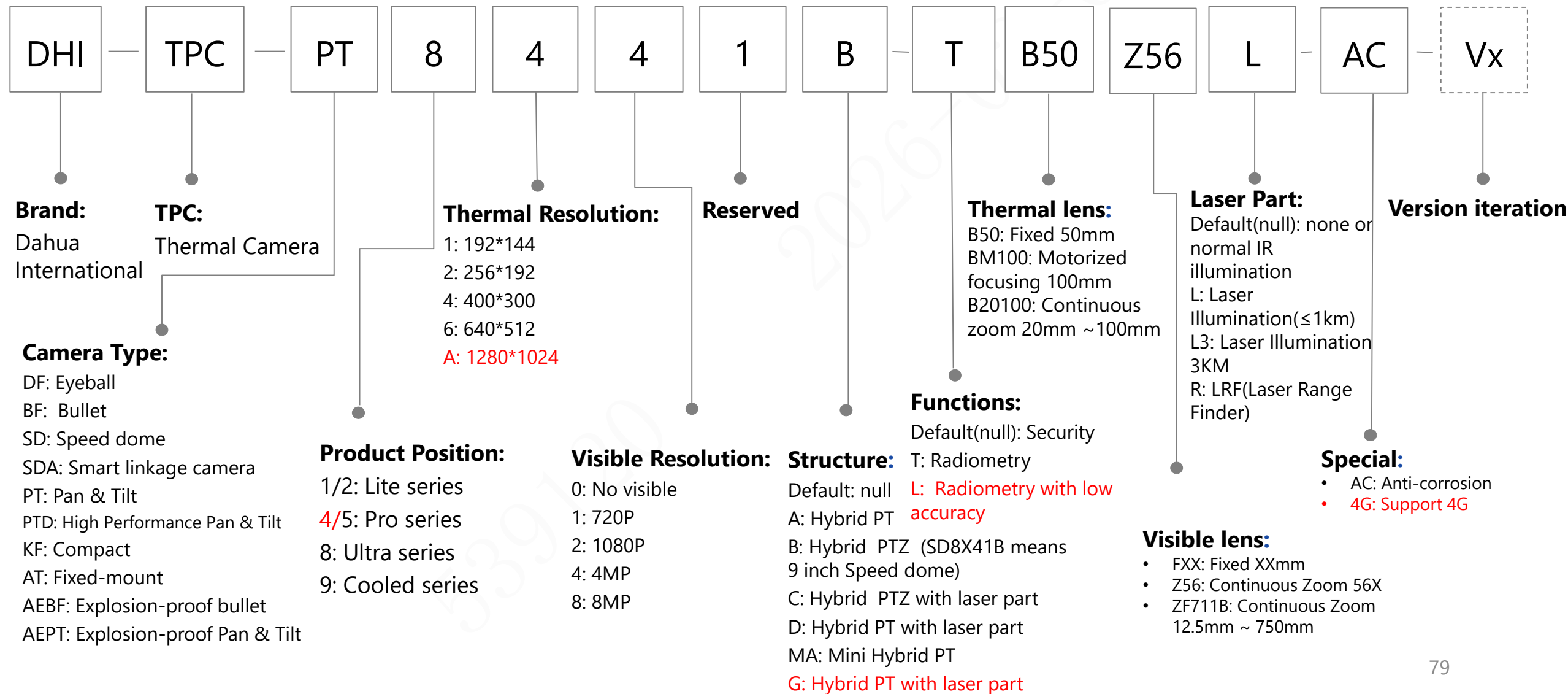

# Thermal Module

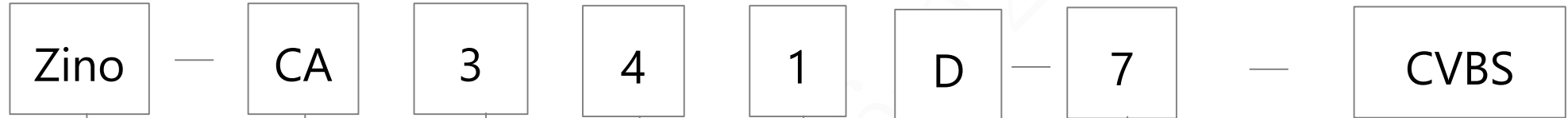

**Public Name:**

Zino26 – 26mm size digital Module  
Mino17 – 17mm size digital module  
Aino – 1280 module

TPC:  
(Old version starts with TPC)

**Product Type:**

CA: Uncooled  
CB: Cooled

**Thermal Resolution:**

2: 256\*192  
4: 384\*288  
6: 640\*512  
A: 1280x1024

**Series:**

5: Security module  
4: Thermography module  
3: 26mm size module  
2: 21mmx21mm module  
1: 17mmx17mm module

**Function:**

0: Security  
1: Thermography

**Network or Digital:**

N: network  
D: Digital

**Thermal Lens:**

Null: no lens  
7: 7/7.5mm  
13: 13mm  
.....

**Interface:**

USB  
CVBS  
HDMI

# Thermal Camera-PVS

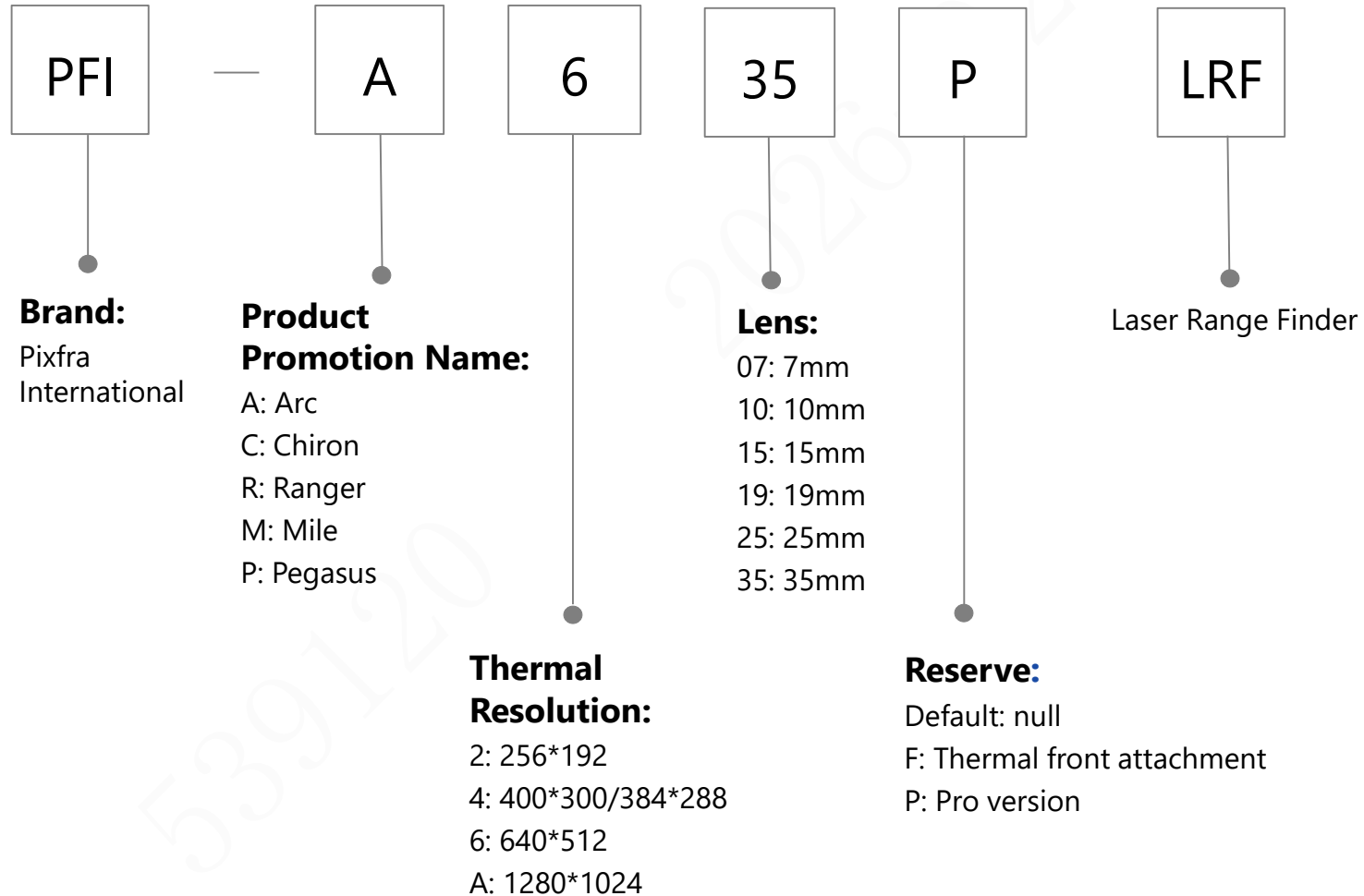

# Handheld Thermography

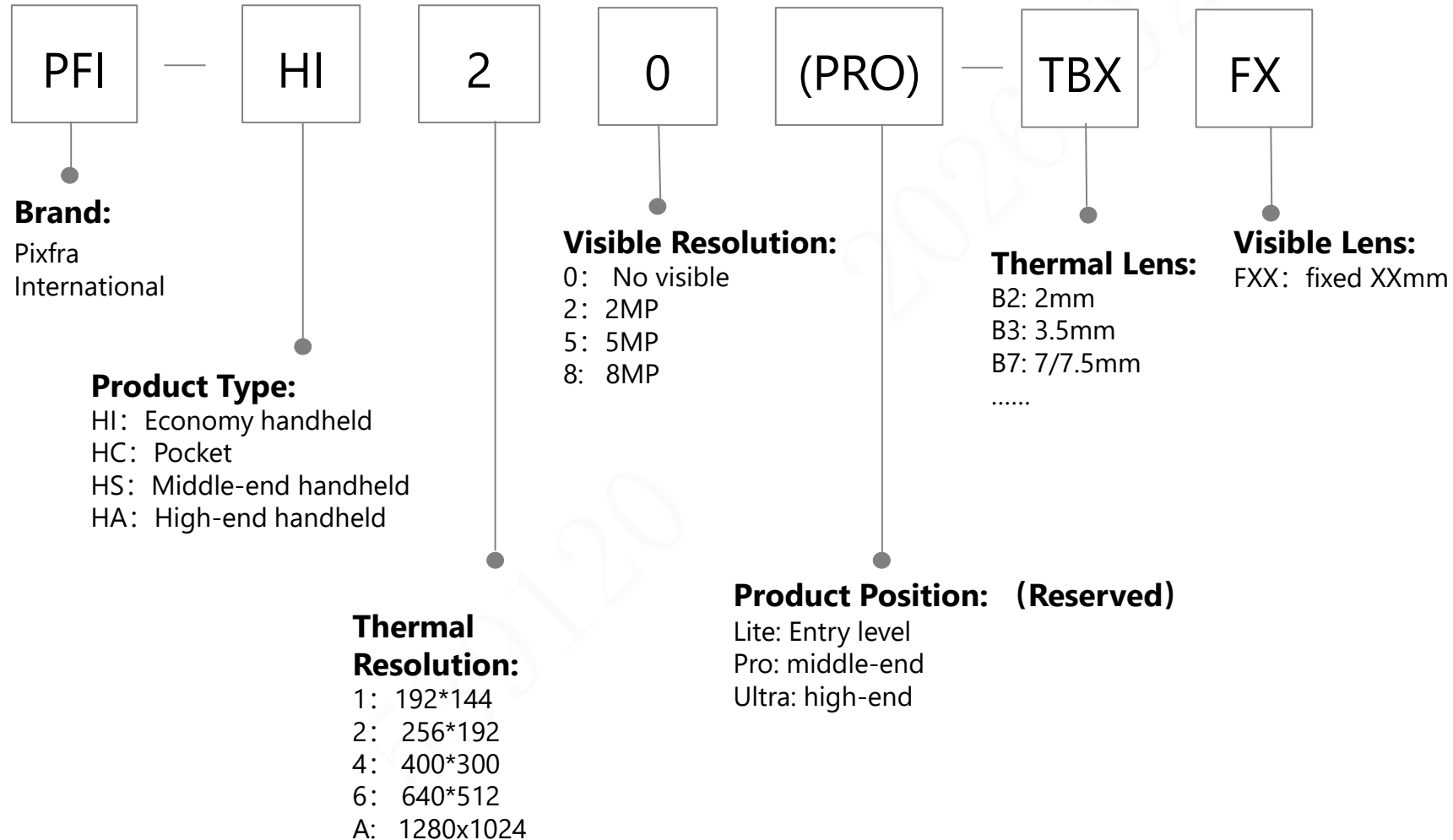

# Monitor-CCTV

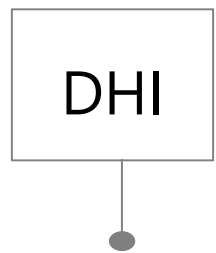

**Brand:**  
Overseas Dahua

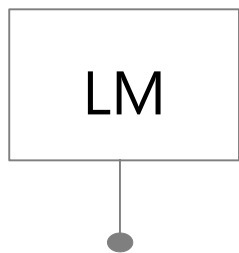

LED Monitor

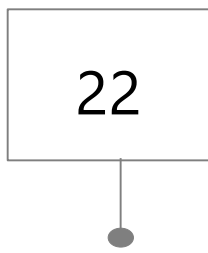

**Size:**  
19: 19"  
22: 22"  
.....  
98: 98"

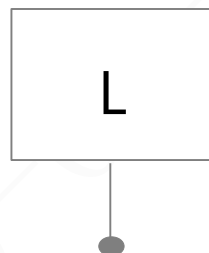

**Positioning:**  
S: High-end level (metal case, high protection)  
F: Standard level (plastic case)  
H: Industry level (plastic case)  
J: Energy-saving model (plastic case, long lifespan)  
L: Entry level (plastic case, cost-effective)

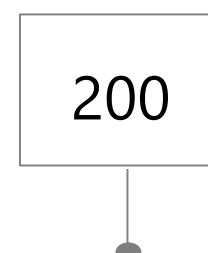

**Resolution:**  
100 < 1080P  
200=1080P  
400=4K

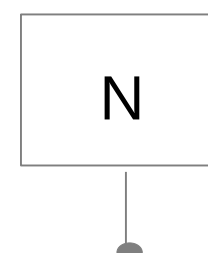

**Reserved**

监视器规格型号命名规则											
		必填		必填	必填		必填	必填	必填	必填	选填
	字段号	①		②	③		④	⑤	⑥	⑦	⑧
液晶监视器产品 (监视器)	标识	公司标识		产品线标识	尺寸标识		产品定位	分辨率	预留1	预留2	功能外观
	实例	DH	-	LM	22	-	S	2	0	0	缺省/A-Z
	说明	DH=大华品牌 DHI=海外大华品牌 缺省=海外中性		LM=液晶监视器	19=尺寸信息19寸 22=尺寸信息22寸 24=尺寸信息24寸 ..... 98=尺寸信息98寸		S=高端款 (金属壳, 多接口) F=主推款 (塑壳, 多接口) H=流量款 (塑壳, 带Speaker) J=节能款 (低功耗长寿命) L=入门款 (塑壳, H+V) V=项目预留	1 < 1080P 2=FHD 3=QHD 4=UHD 5=5K	位号预留, 默认0	位号预留, 默认0	C: 曲面屏 N, Y: 预留, 用于市场差异化宣传
典型范例		DHI-LM22-J200									



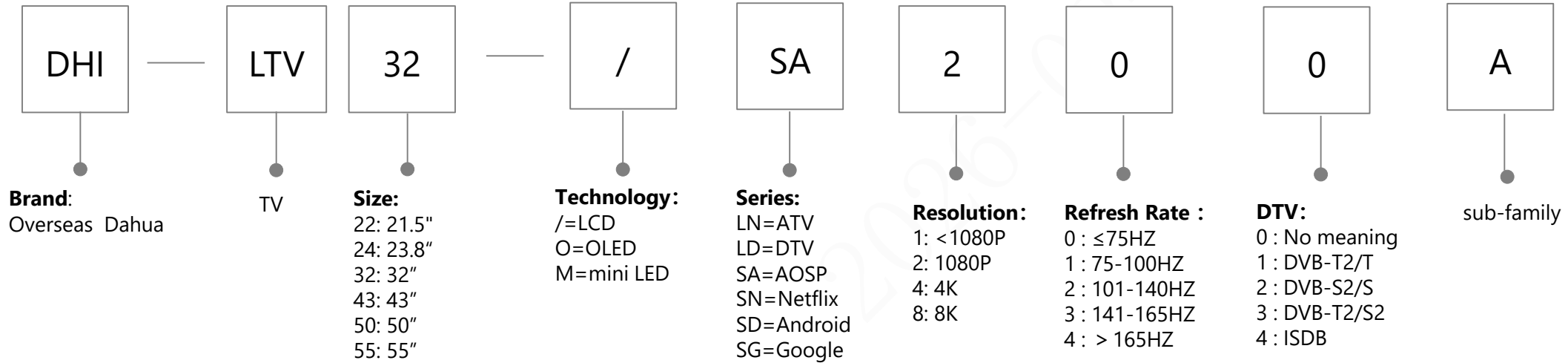

电视机外部型号命名规则

	必填		必填	必填		选填	必填	选填 (D/G必填)	必填	必填	必填	选填
字段号	①		②	③		④	⑤	⑥	⑦	⑧	⑨	⑩
标识	公司标识		产品线标识	尺寸标识		技术	性能	系列名称	分辨率	刷新率	制式	缺省
实例	DHI	-	LTV	32	-	/	SA	/	2	0	0	
说明	DH=大华品牌 DHI=海外大华品牌 FSI=丰视海外 H=国内中性 缺省=海外中性		LTV=电视机	17=尺寸信息17寸 19=尺寸信息19寸 22=尺寸信息22寸 ..... 98=尺寸信息98寸		/=LCD O=OLED M=mini LED	LN=模拟ATV LD=数字DTV SA=智能 (AOSP) SN=智能 (Linux+Netflix) SD=智能 (Android) SG=智能 (Google)		1≤720P 2=FHD/WFHD/1600*900 3=QHD/WQHD 4=UHD/WUHD	0:≤75HZ 1: 75-100HZ 2: 101-140HZ 3:141-165HZ 4: > 165HZ	0-无含义 1-DVB-T2/T 2-DVB-S2/S 3-DVB-T2/S2 4-ISDB	

DHI-LTV32- SA200

# LCD Video Wall

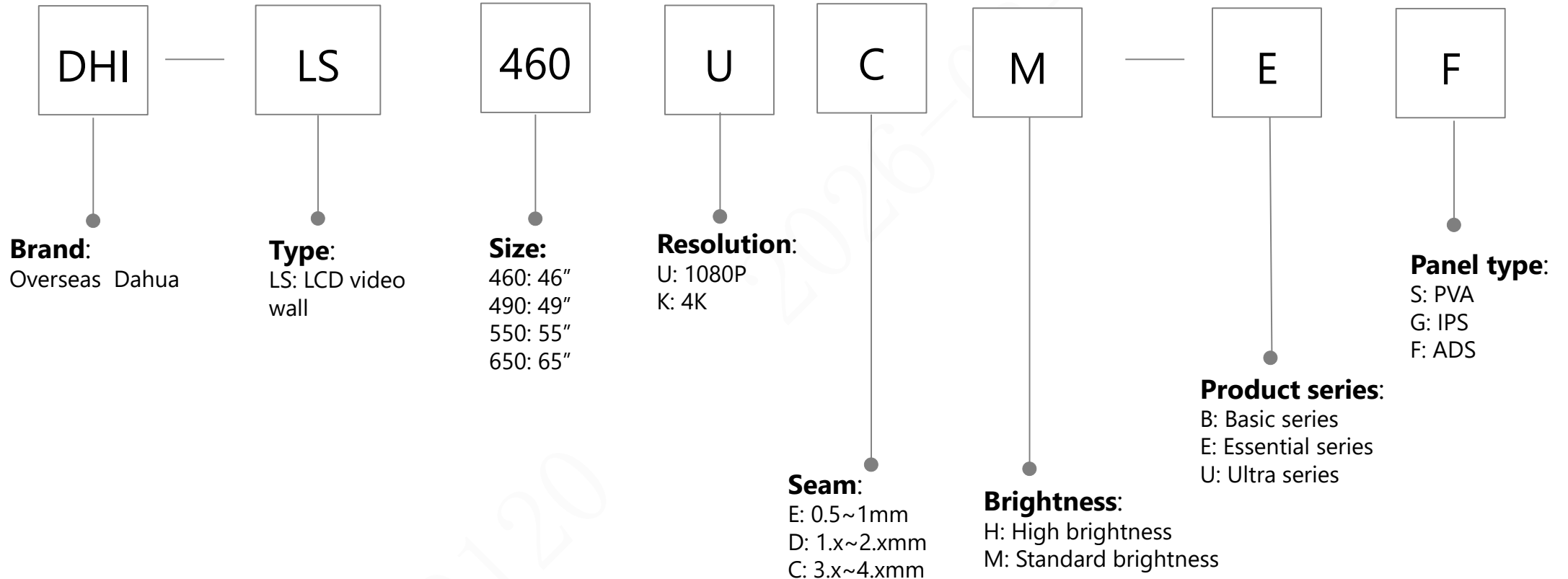

# Digital Signage

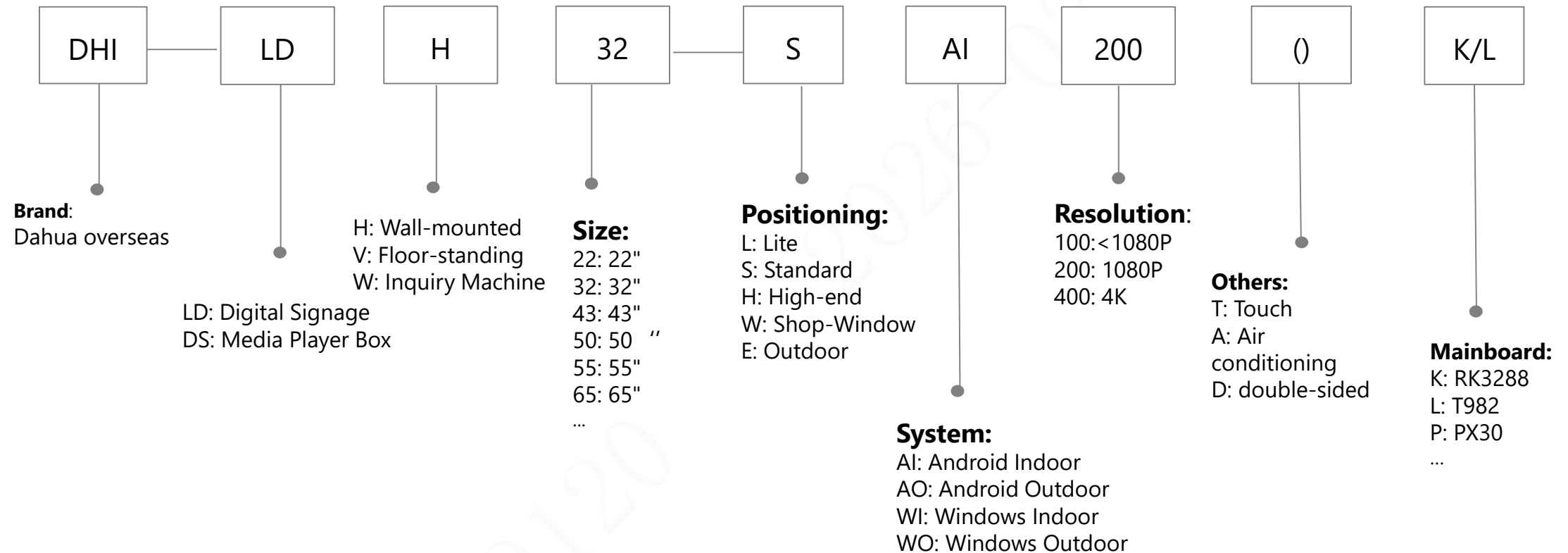

# LED Display

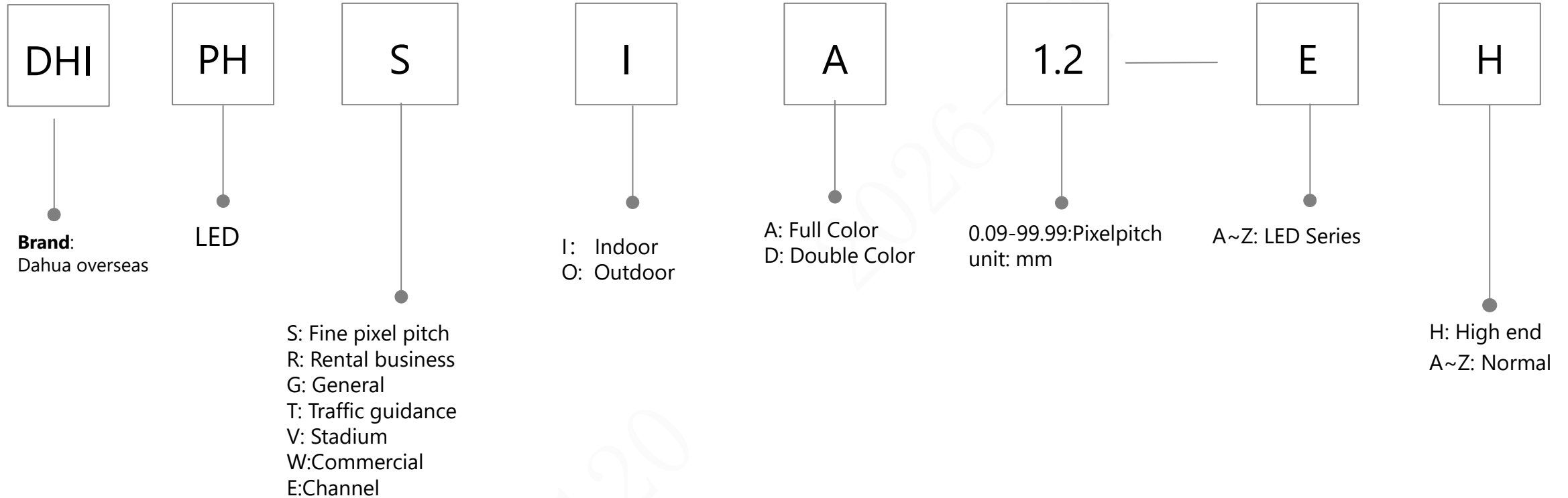

# Decoder

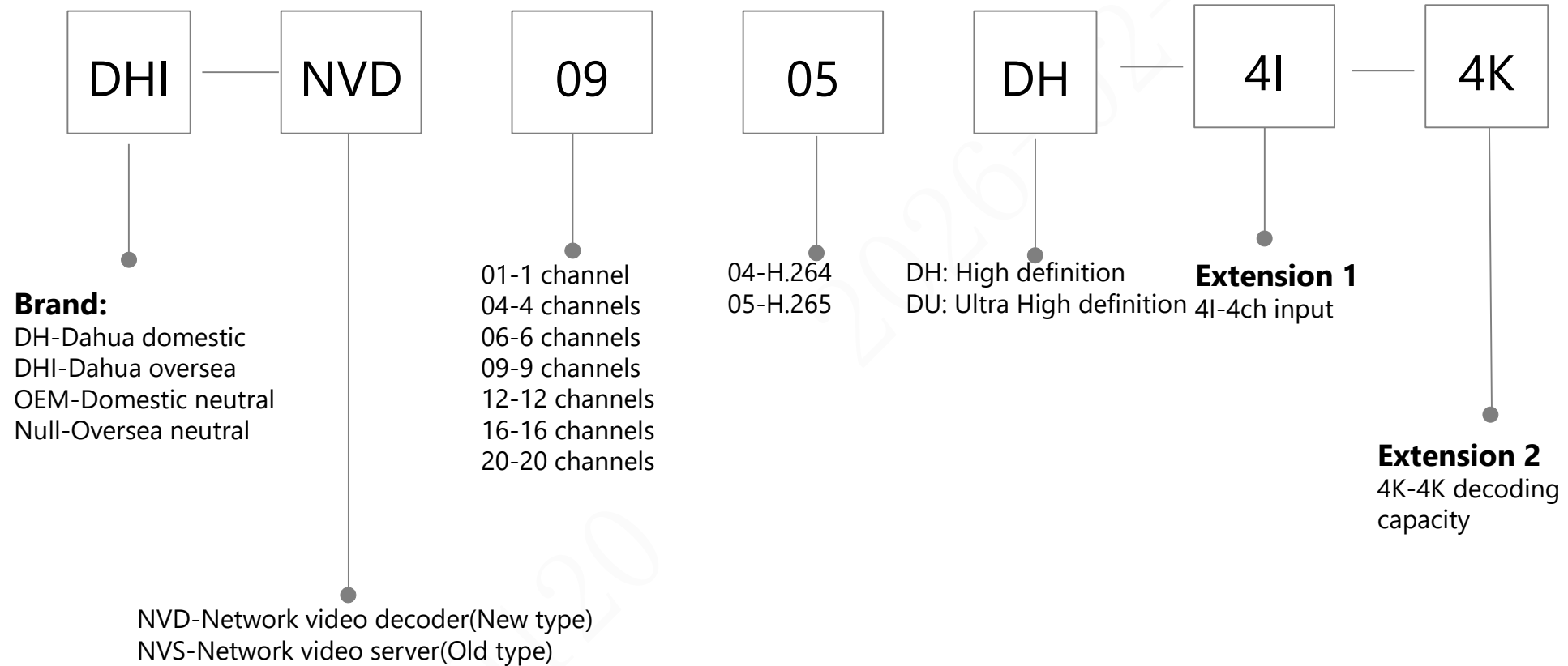

# Matrix--Mainframe box

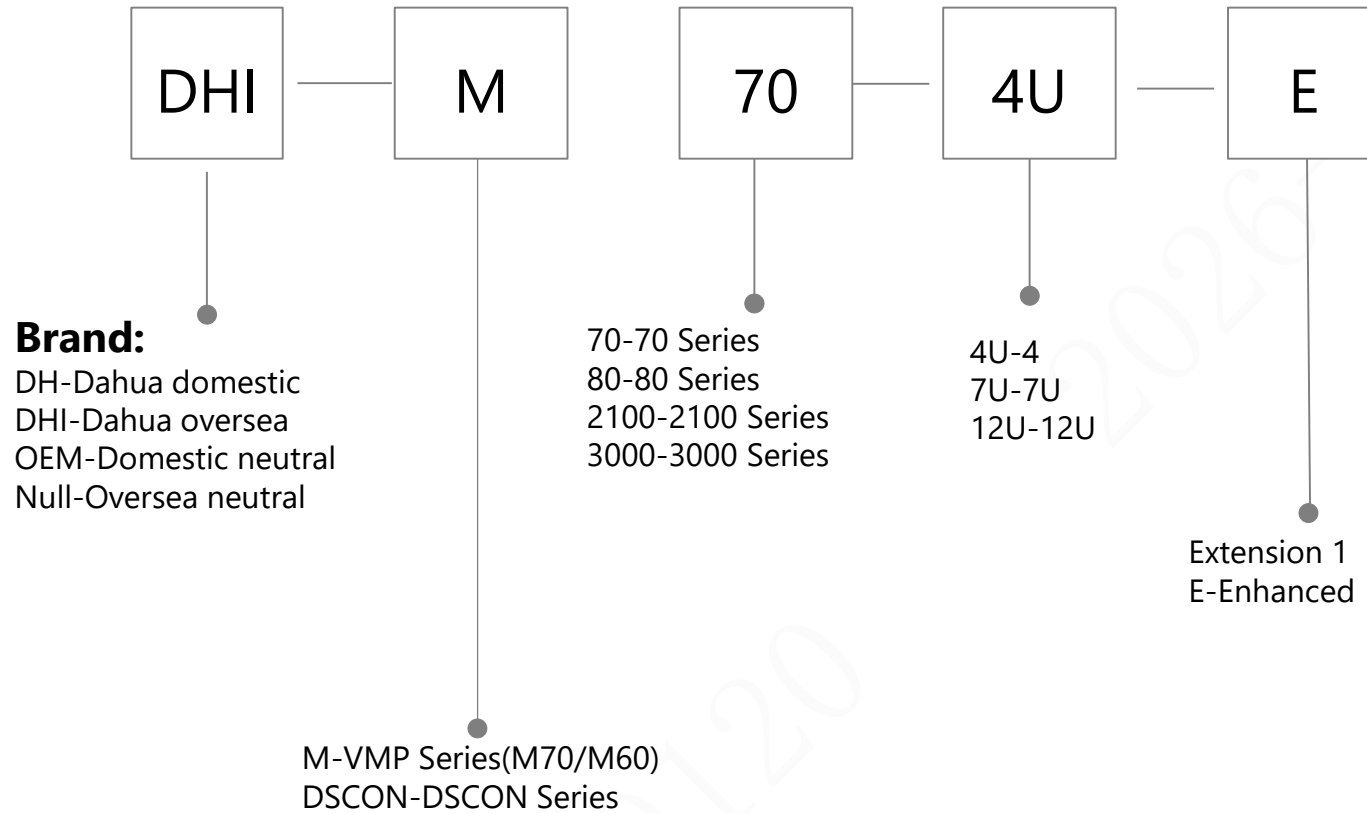

# Matrix--Input/Output Card

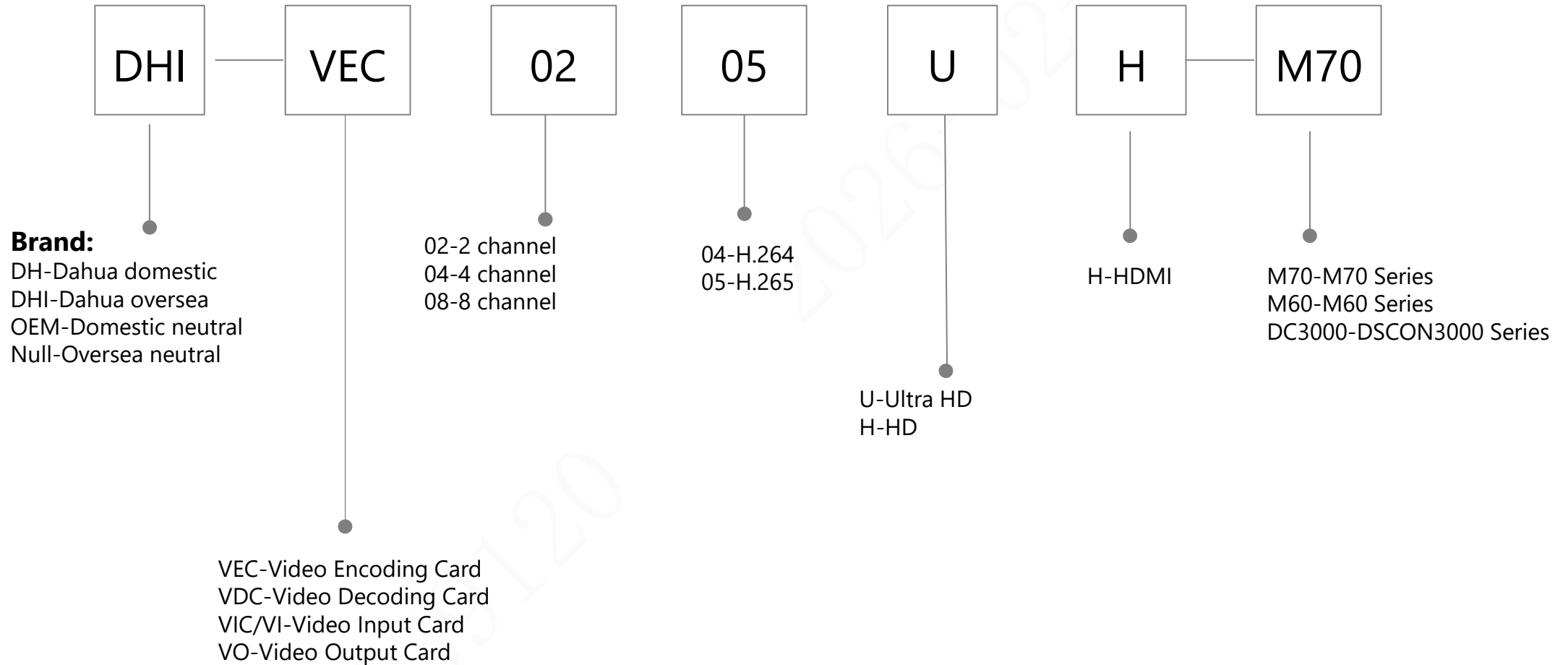

# AVoIP

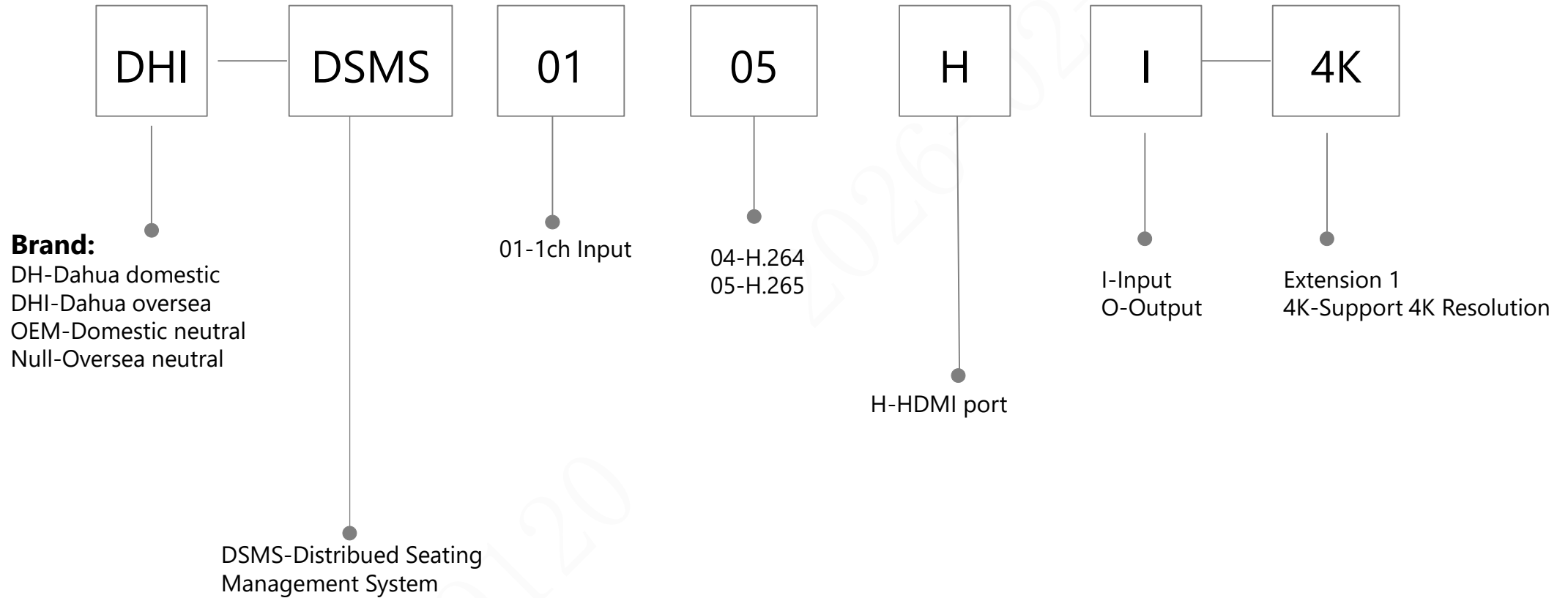

# AVoIP

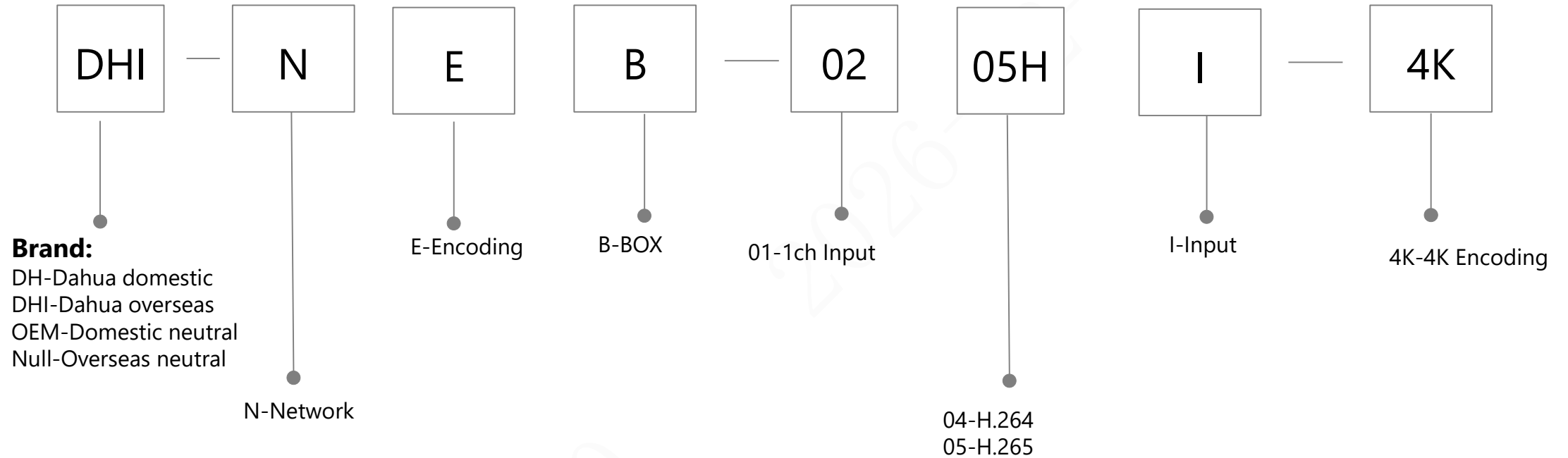

# Speaker

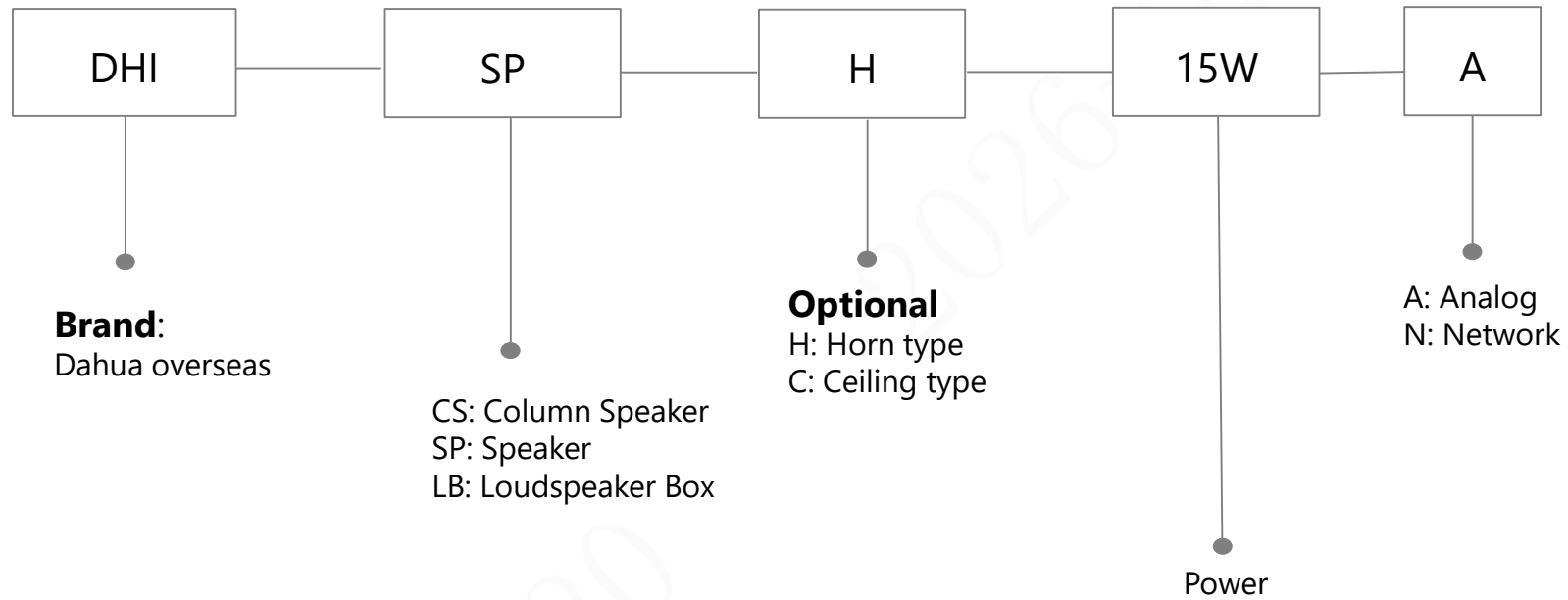

# Pickup

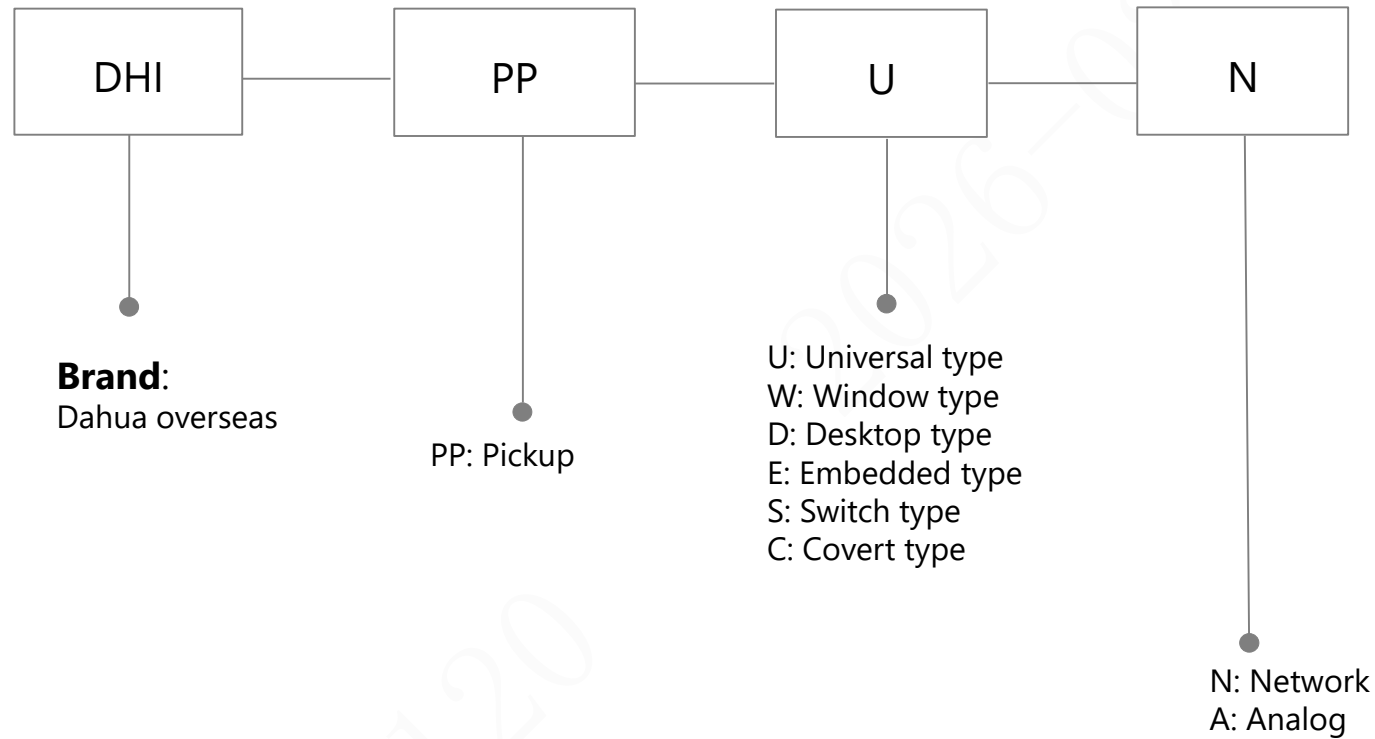

# Power Amplifier

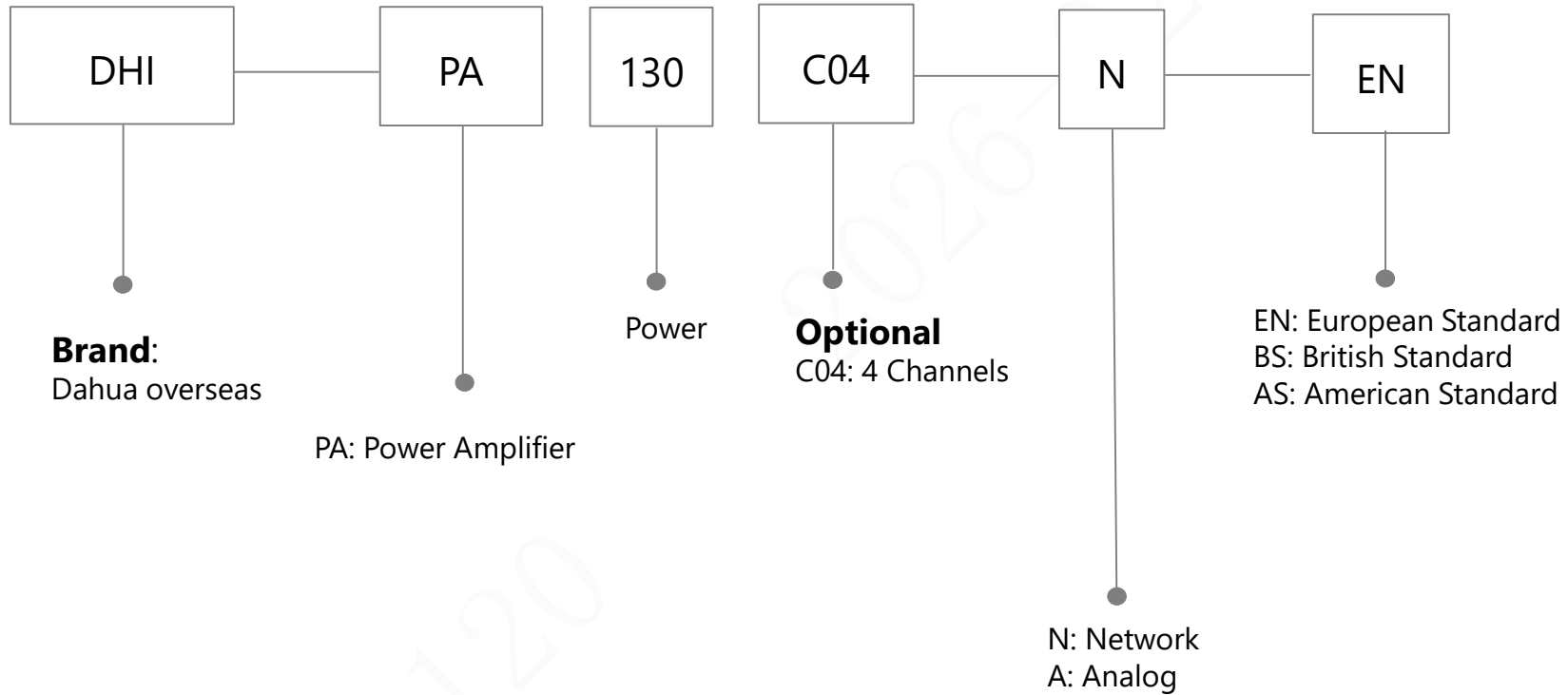

# Microphone

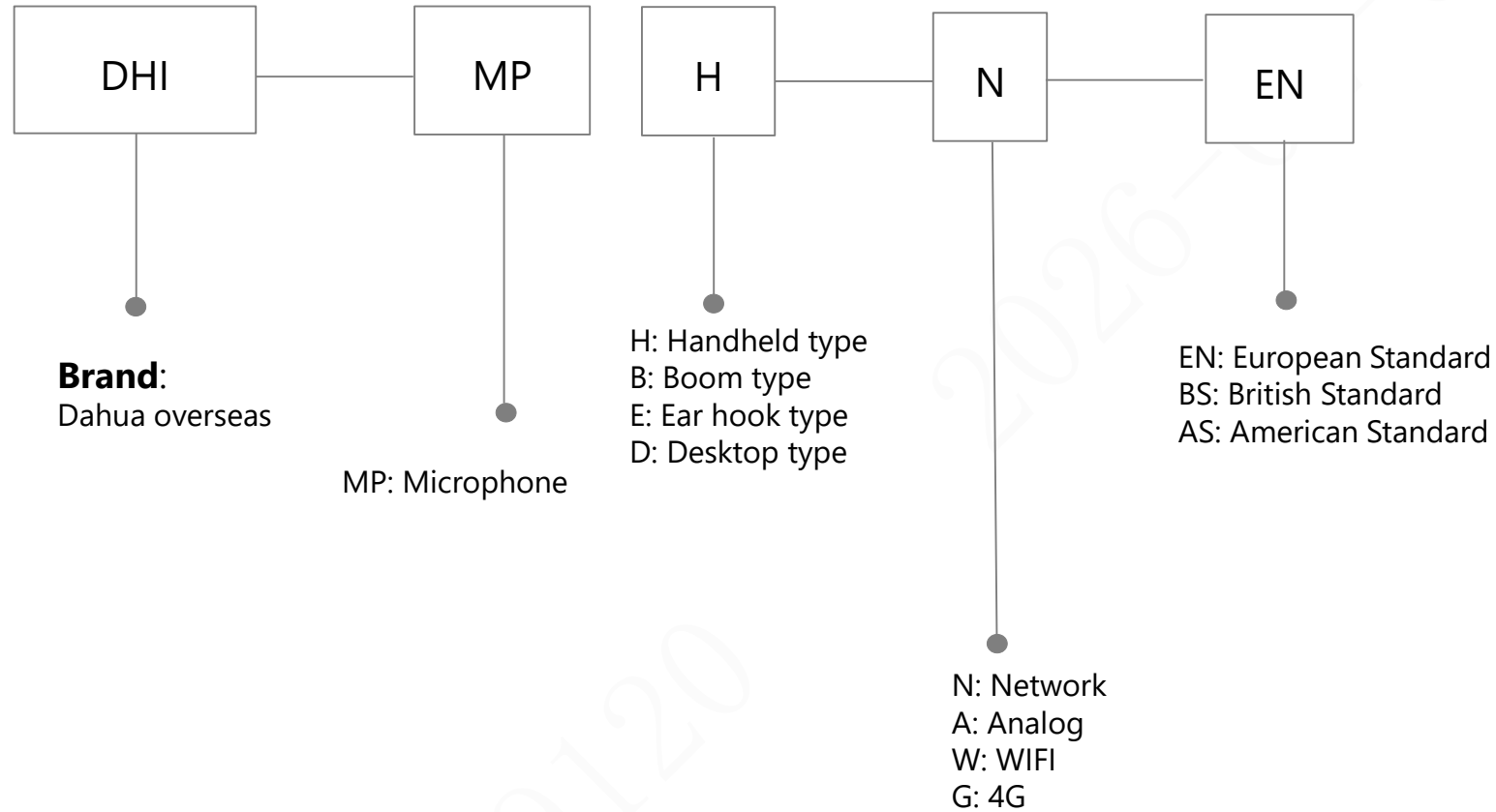

# Metal Detector

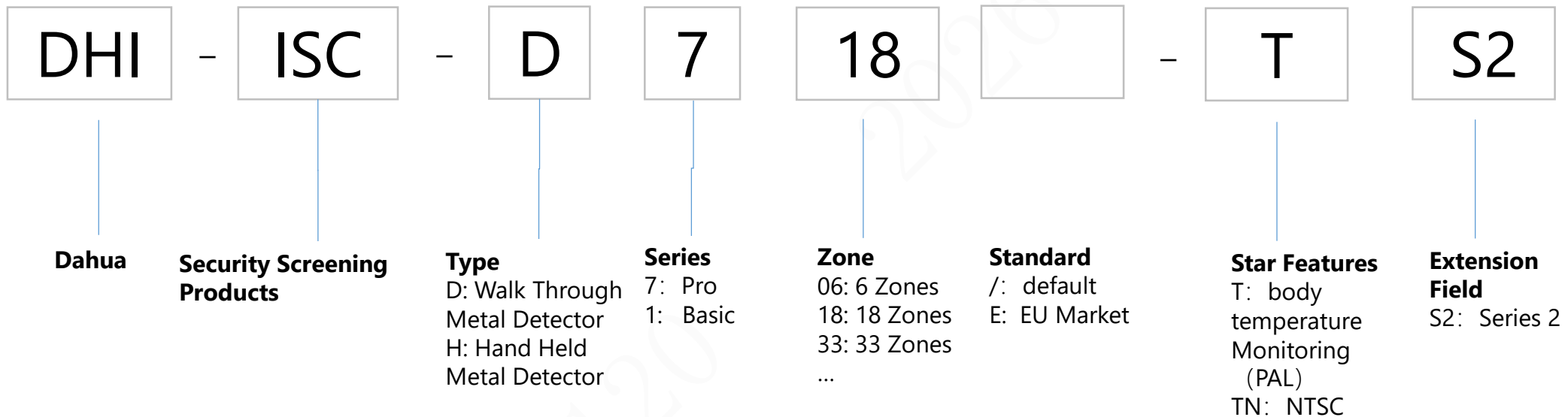

# Baggage & Parcel Screening

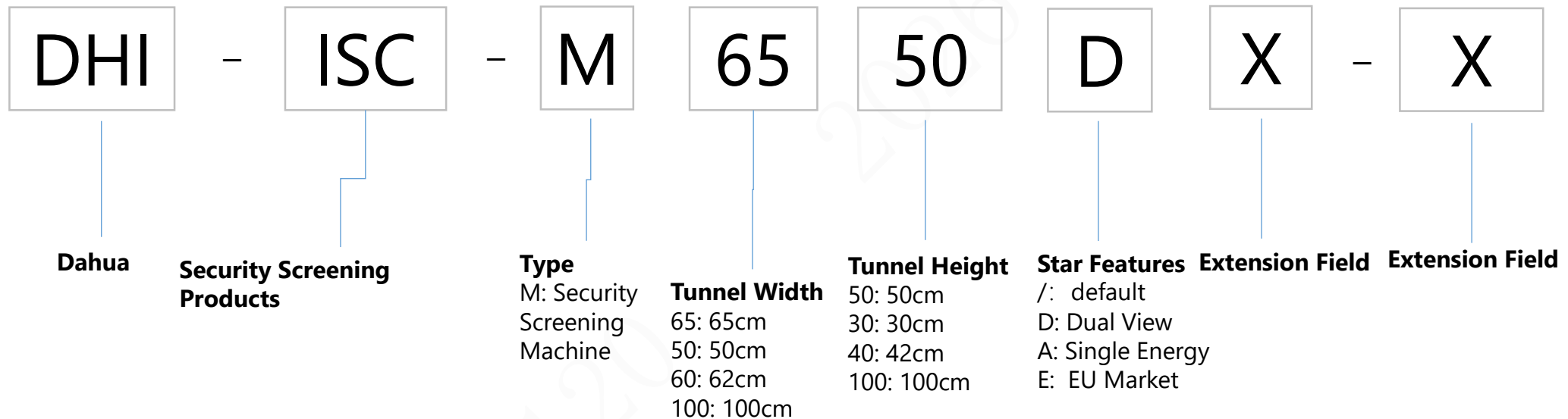

# EAS Labels & Tags

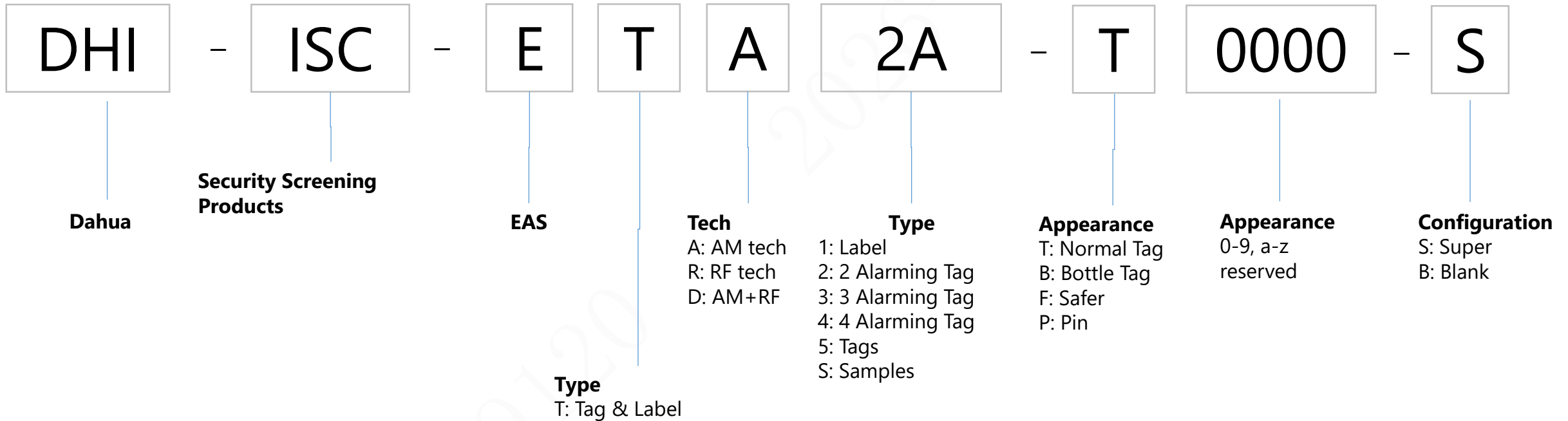

# EAS antenna

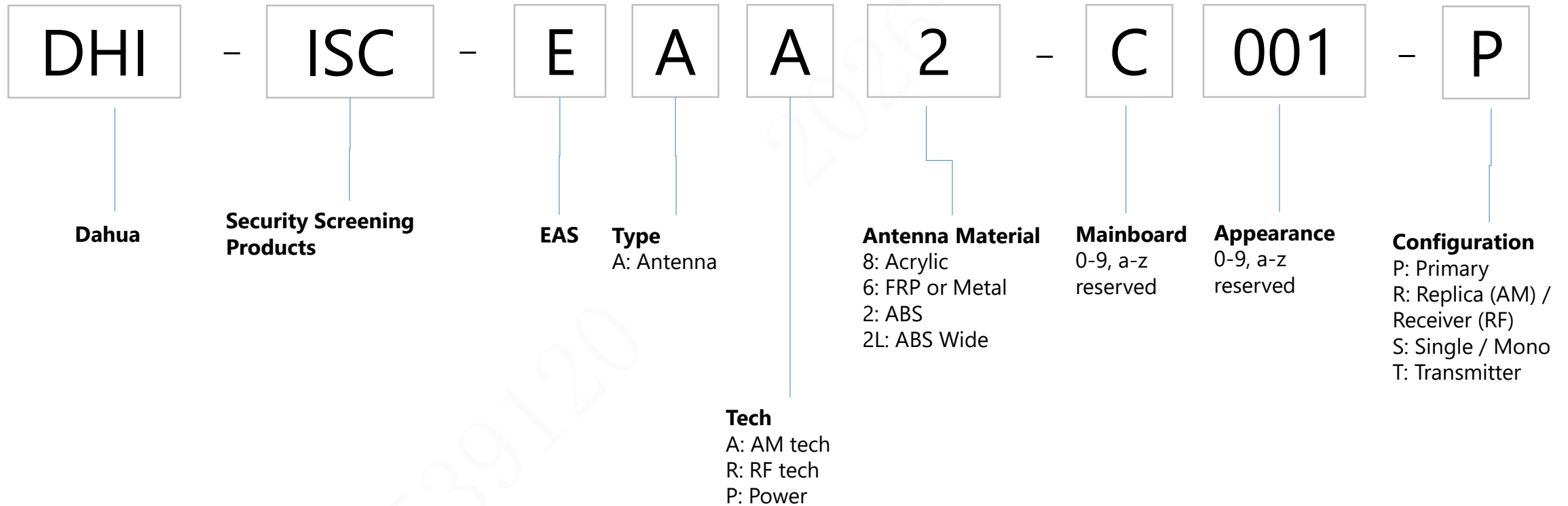

# Mobile IPC

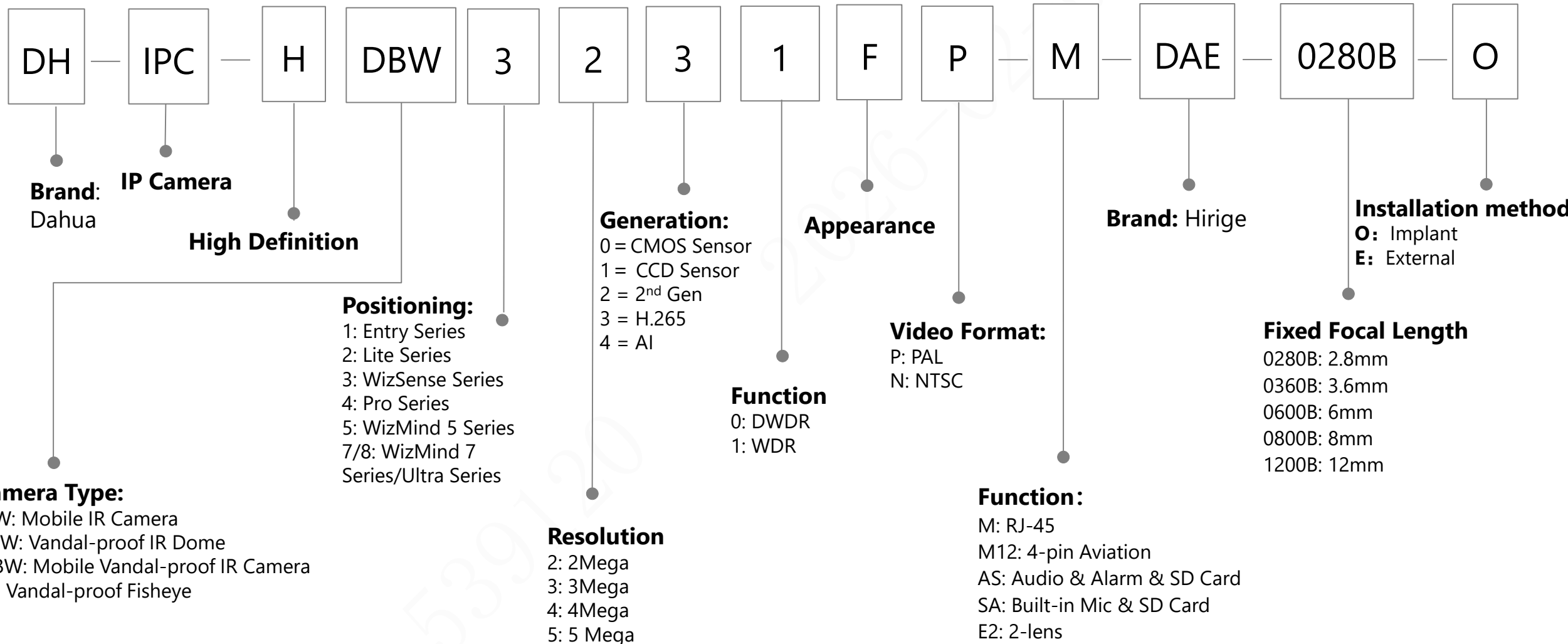

# Mobile HDCVI Camera

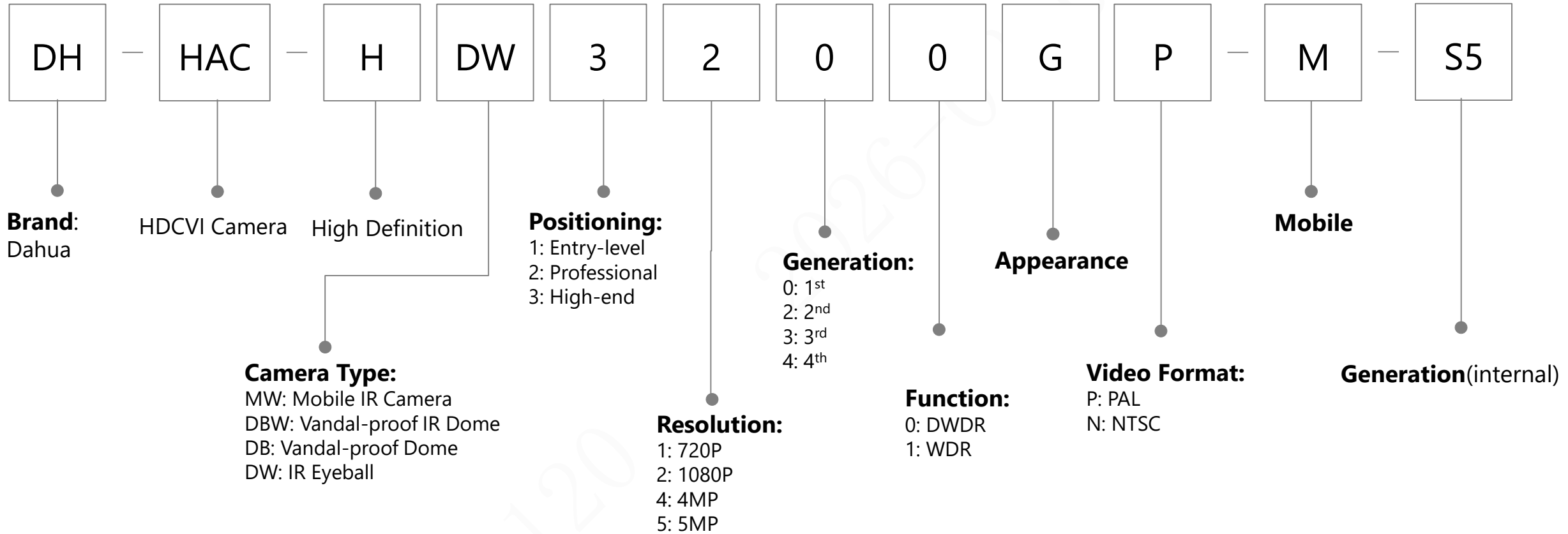

# Dash Camera

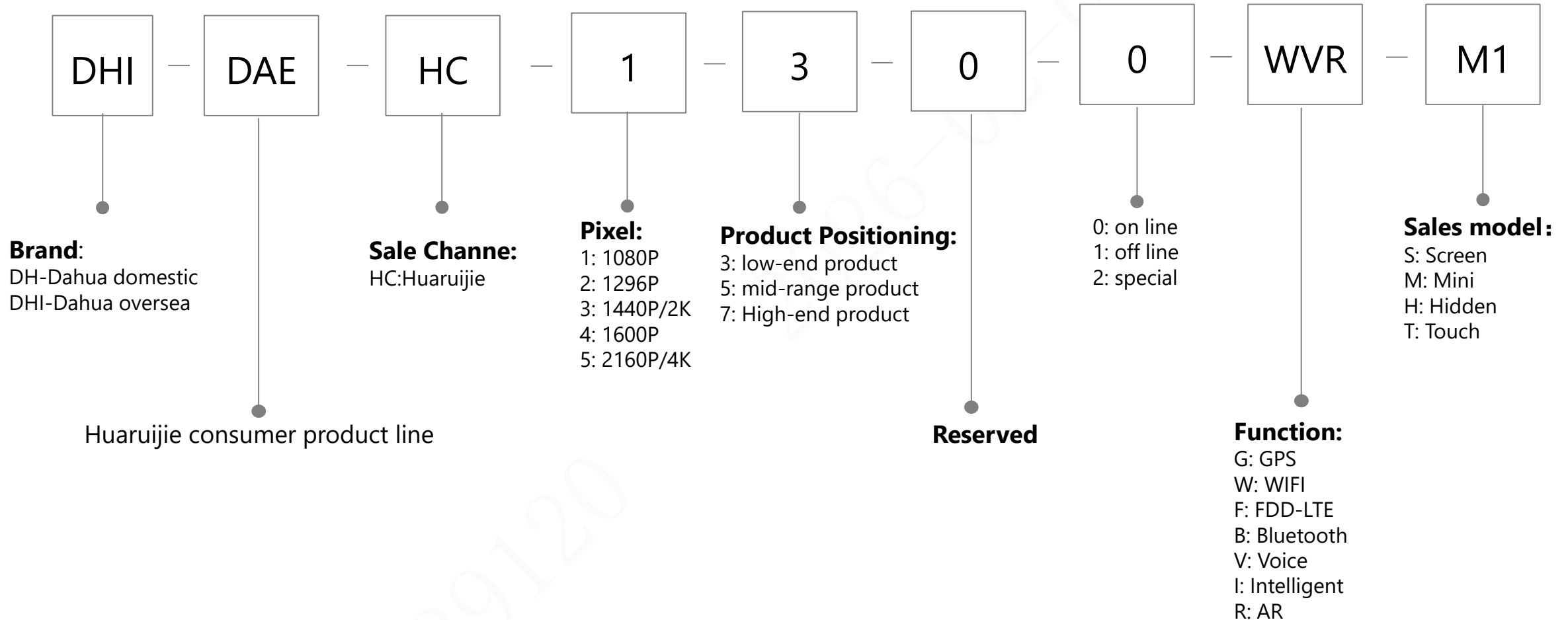

# Mobile DVR/NVR

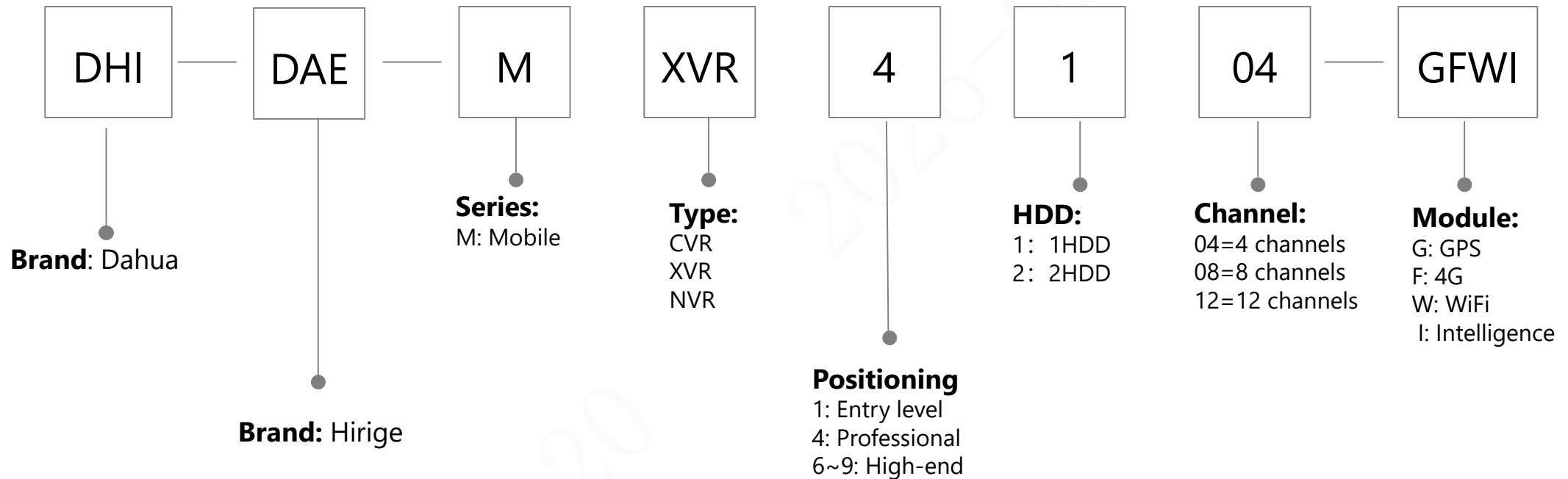

# Mobile Active Safety Camera (1/2)

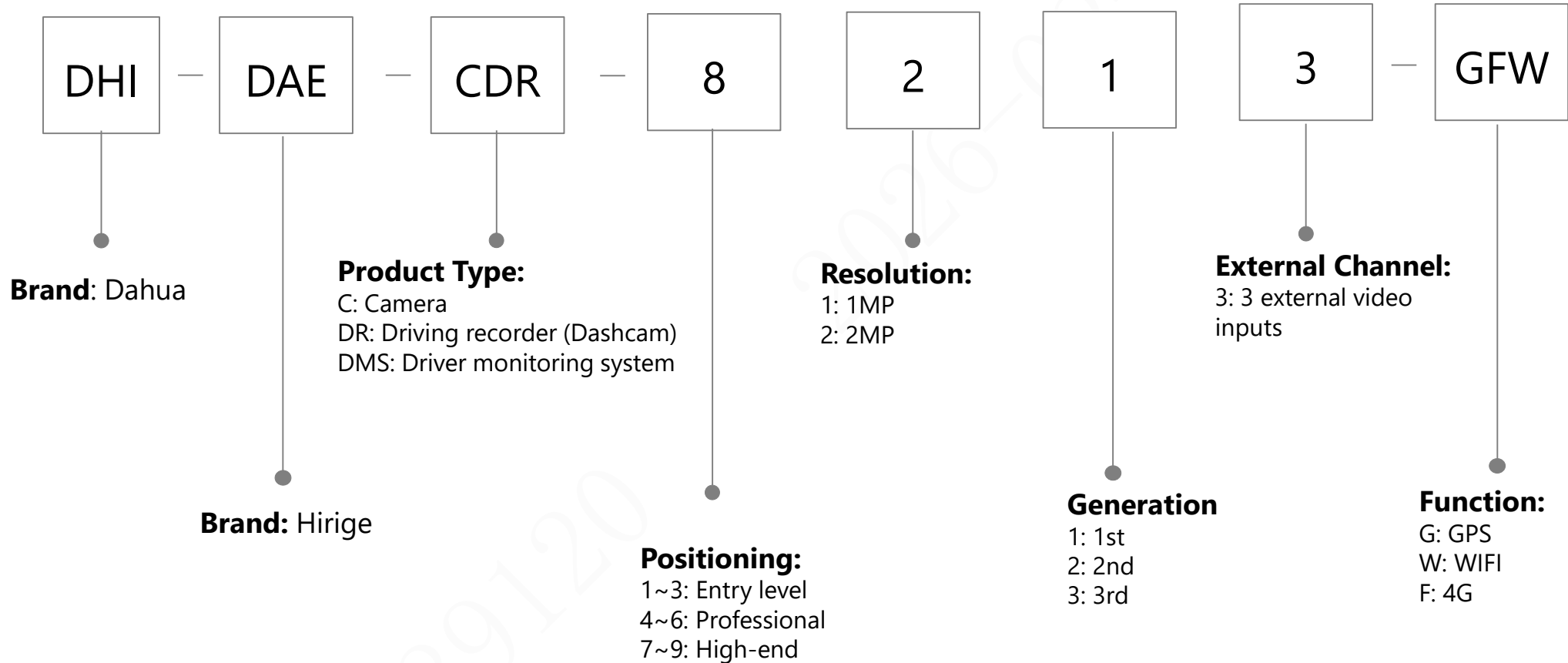

# Mobile Active Safety Camera (2/2)

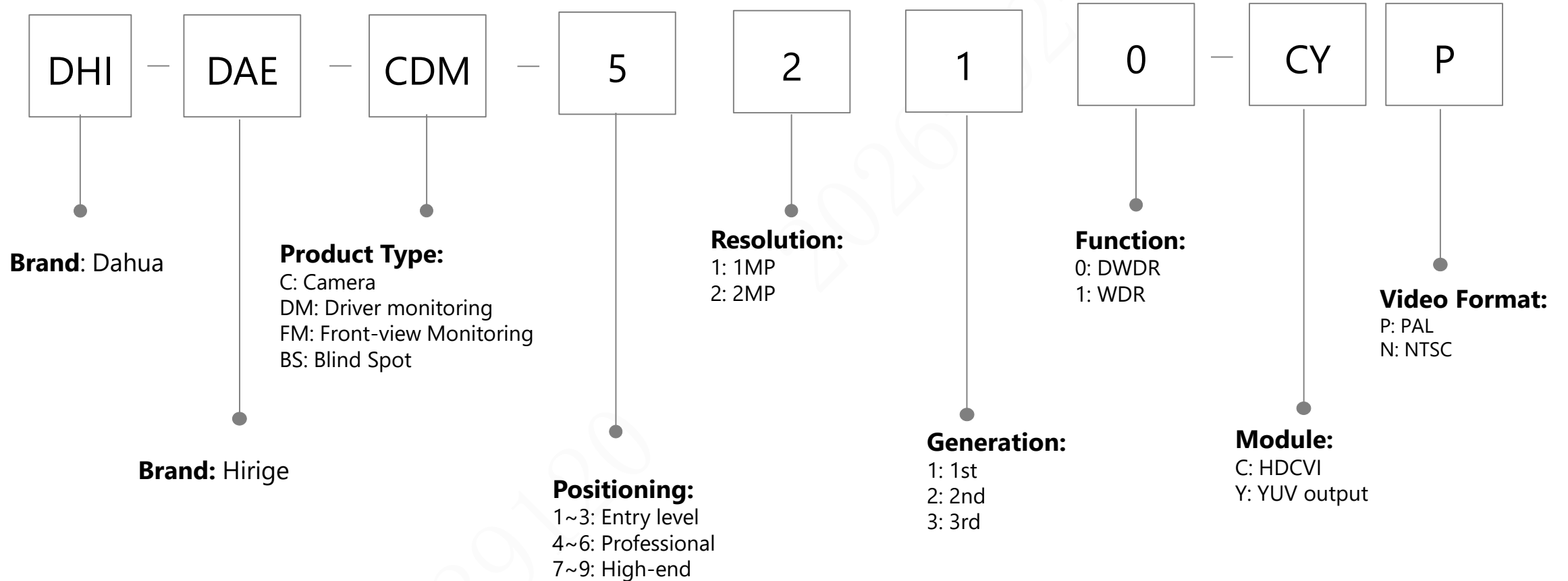

# Residential Fire Alarm Series(New Gen)

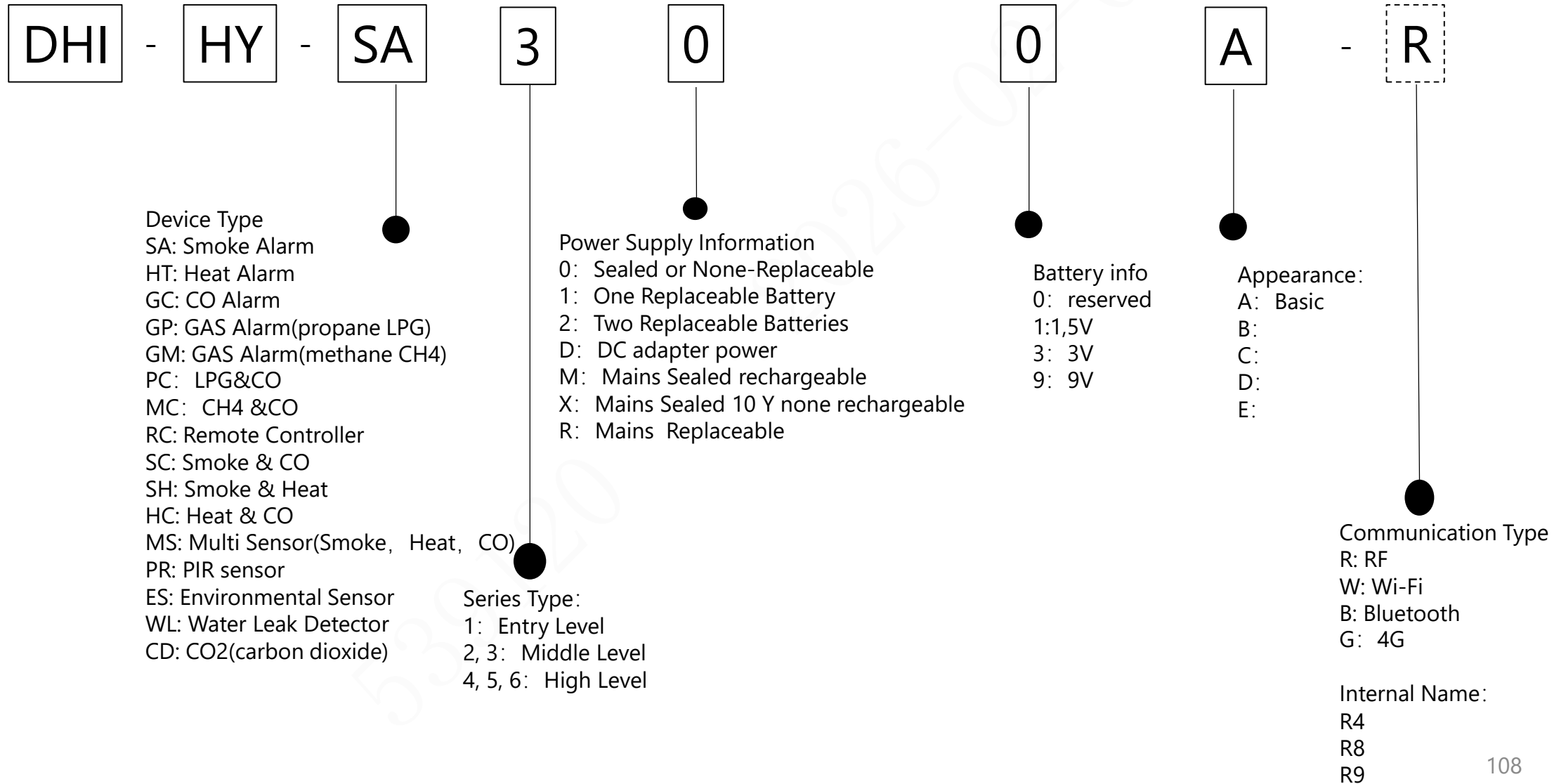

# Commercial Fire Alarm Series (New Gen)

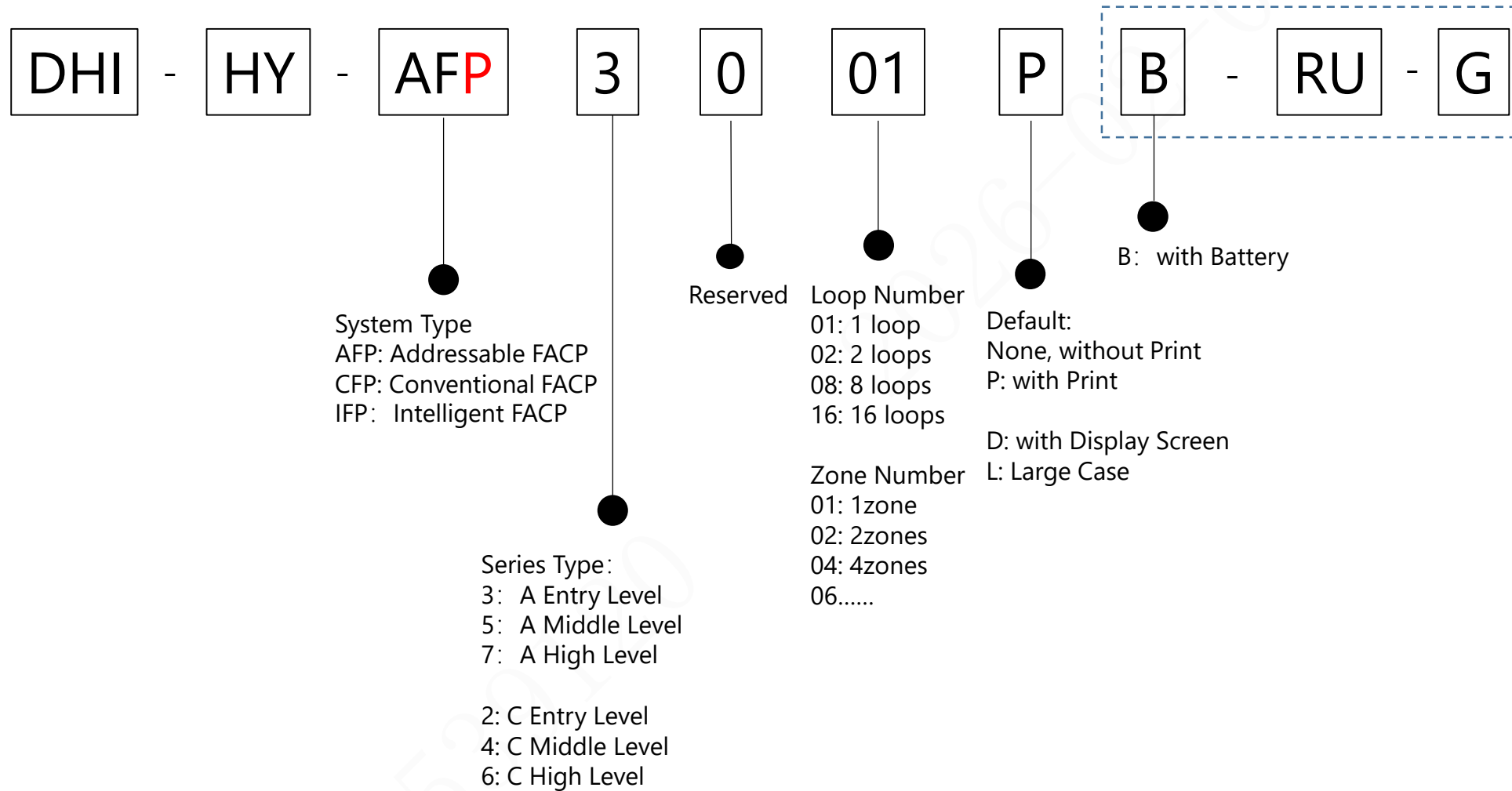

# Commercial Fire Alarm Series (New Gen)

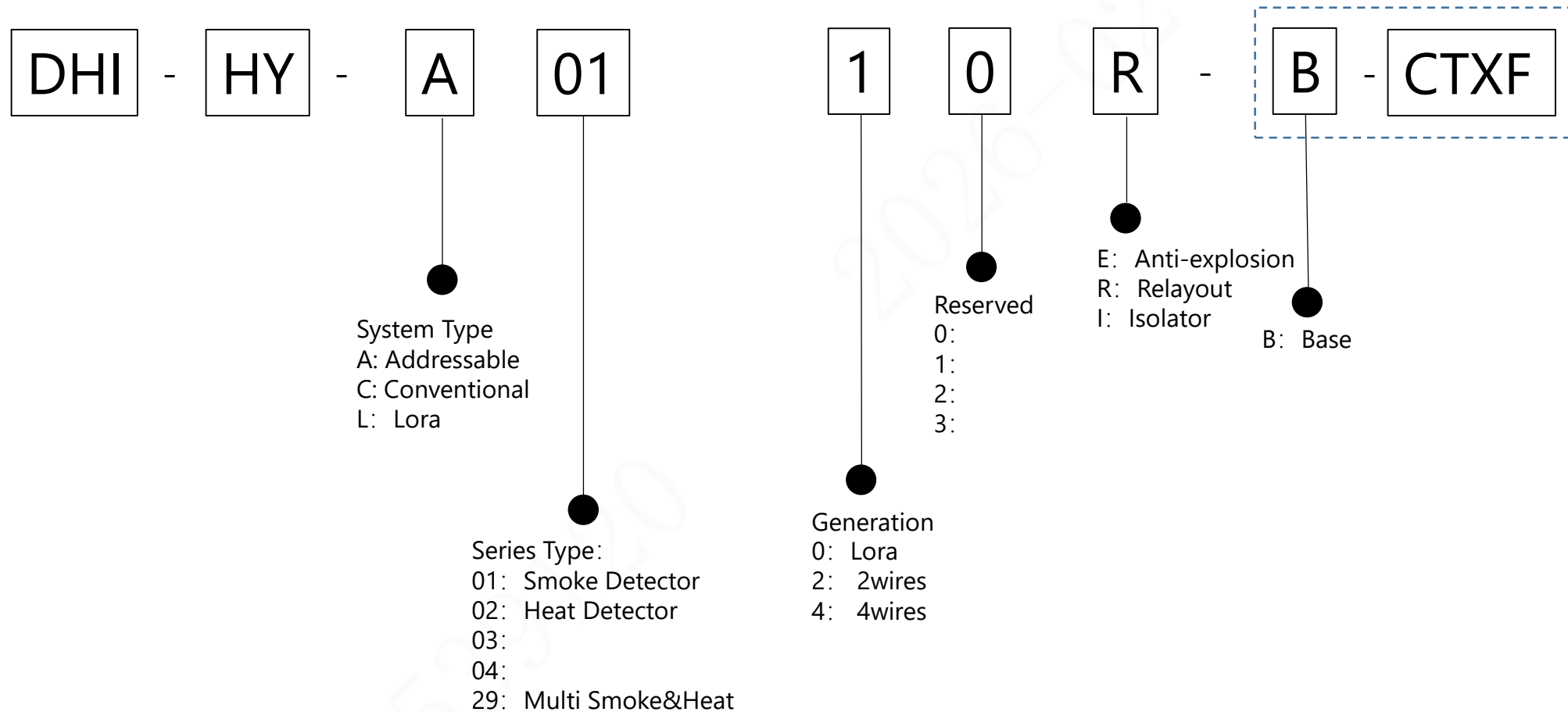

# Microinverter

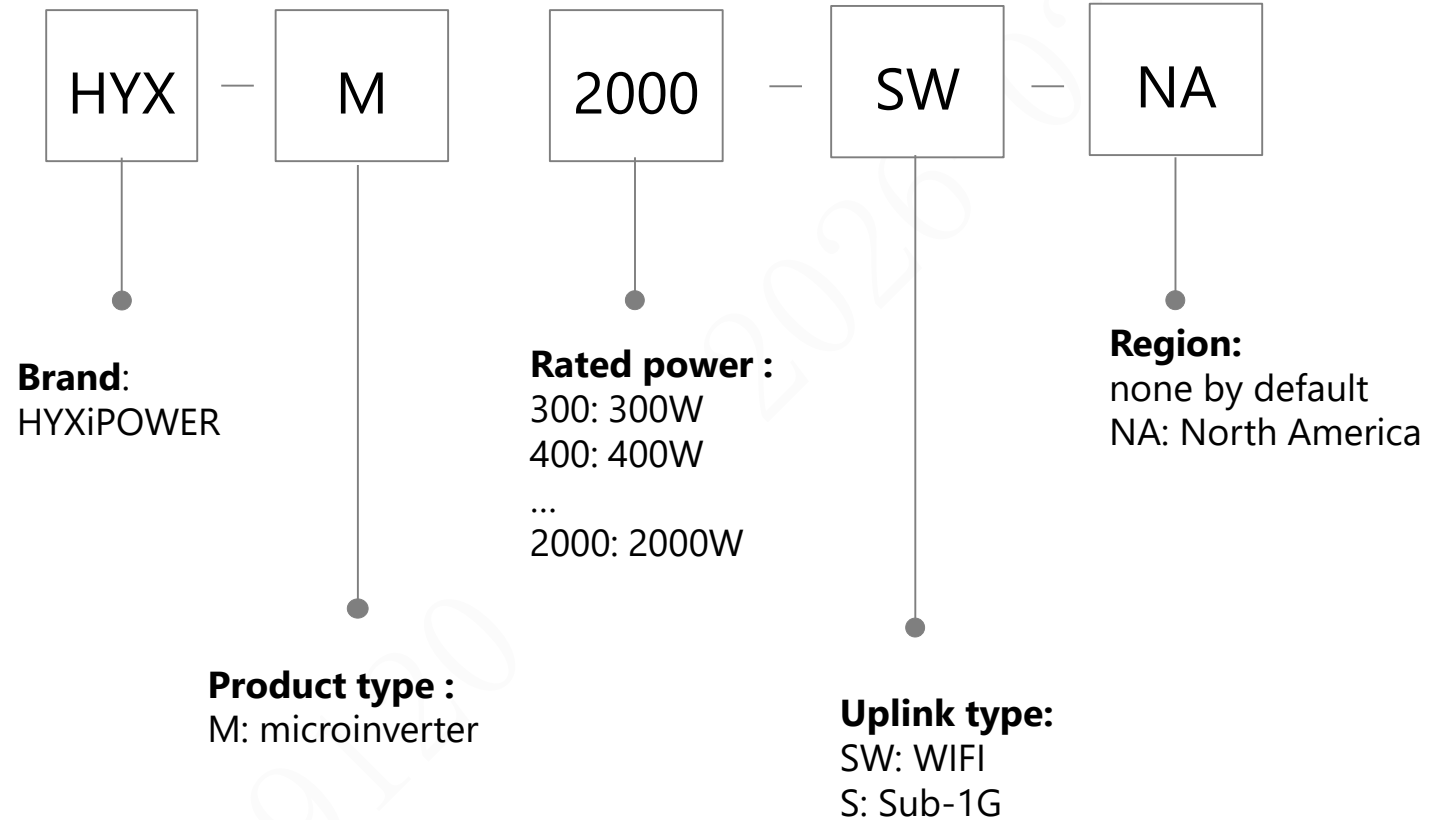

# String Inverter

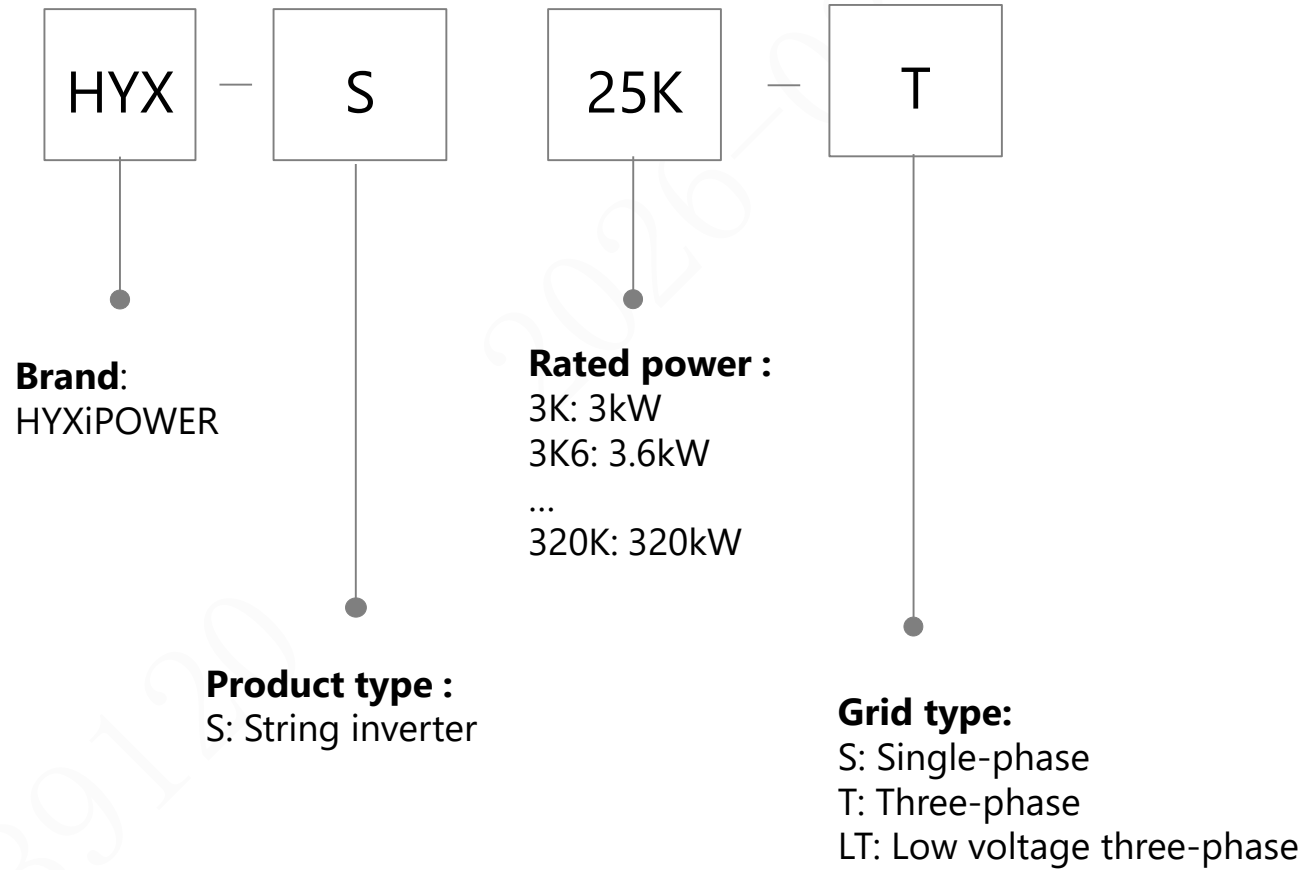

# Hybrid Inverter

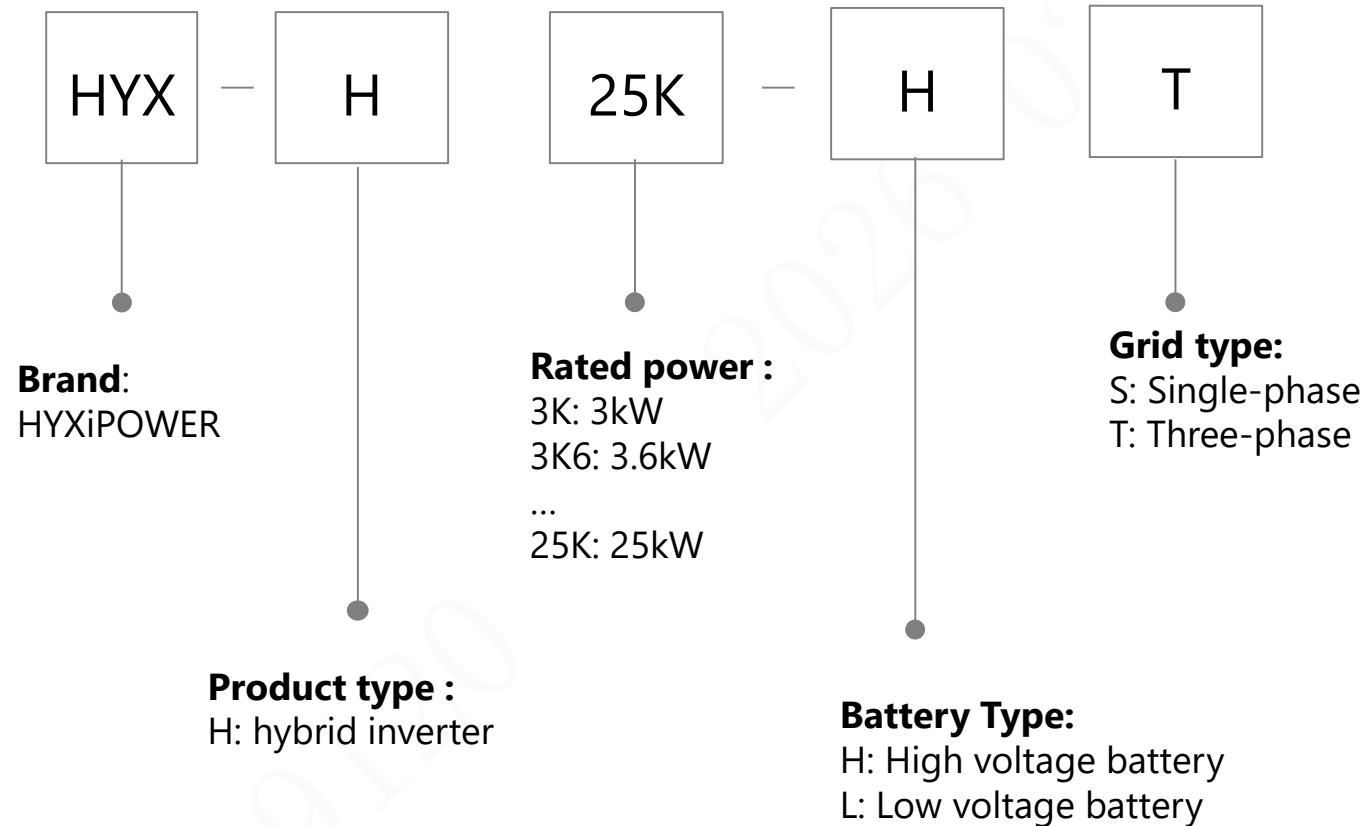

# Residential Battery



Model Name

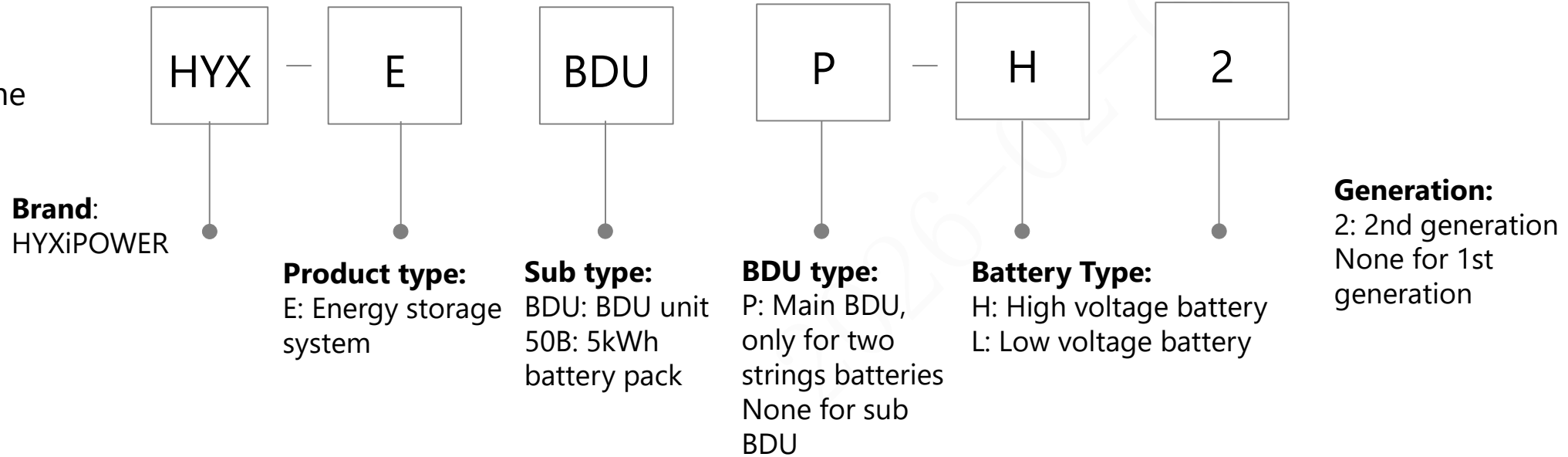

System Name

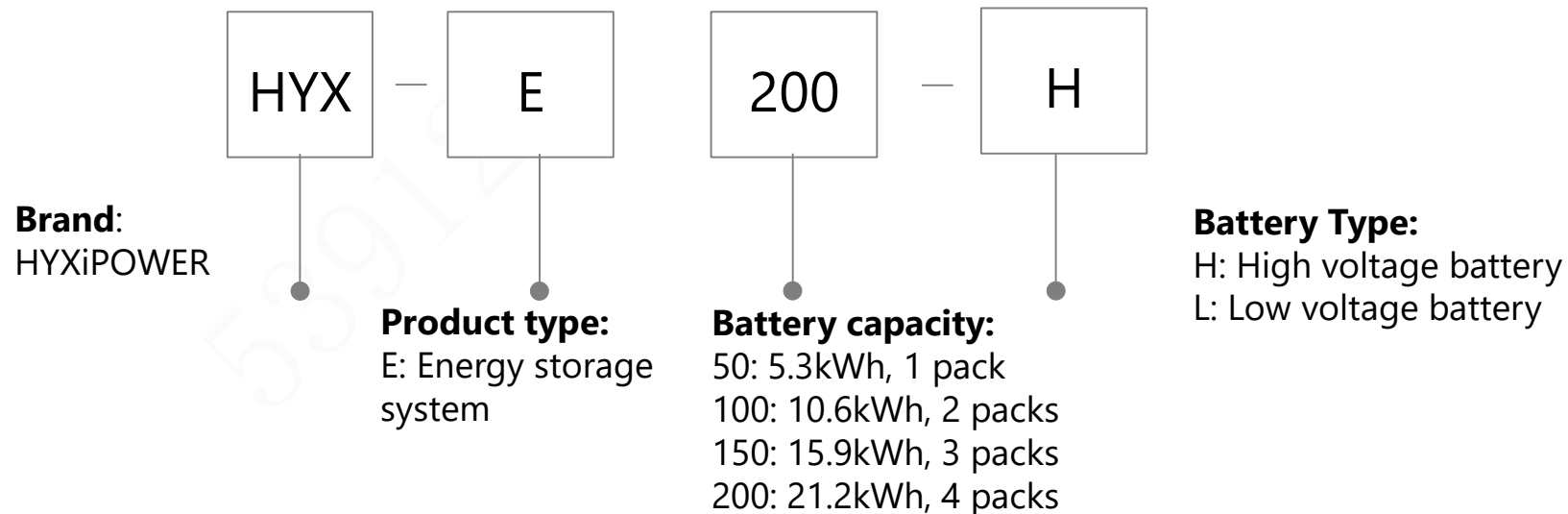

# C&I ESS



ESS cabinet

HYX

—

EL

232

P2

—

DC

**Brand:**  
HYXiPOWER

**Product type :**  
E: Energy storage system  
L: Liquid Cooling  
F: Forced Air Cooling

**ESS capacity :**  
215: 215kWh  
232: 232kWh  
372: 372kWh

**Charge rate:**  
P2: Use 2h to charge full  
P1: Use 1h to charge full

**Output Type:**  
DC: DC Output, none by default, AC output  
M: MPPT  
S: STS

Outdoor battery cabinet

HYX

—

BOA

215

**Brand:**  
HYXiPOWER

**Product type :**  
B: Battery  
O: Outdoor cabinet  
A: Air cooling pack

**ESS capacity :**  
215: 215kWh

# C&I ESS

Outdoor battery cabinet

HYX

—

BOA

215

**Brand:**  
HYXiPOWER

**Product type :**  
B: Battery  
O: Outdoor cabinet  
A: Air cooling pack

**ESS capacity :**  
215: 215kWh